



Montasjeanvisninger:

MV-Brannklassifisert EI30

Tegn.nr

6002141	EI30-Byggeplassens sjekklister
6001858	Glass og veggmodul, tilslutninger og sammenføyninger
6001859	Glass og veggmodul, tilslutninger og sammenføyninger
6001860	Montering EI30 tettmodul
6001855	V-Fas montert med rammeprofil- tilsluttet EI30 tettmodul
6001854	V-Fas montert med U. svill- tilsluttet EI30 tettmodul
6001850	Hatteprofil med rammeprofil-tilsluttet EI30 tettmodul
6001468	Montering glassfelt EW30- 90° hjørneprofil
6001520	Montering glassfelt EW30- 45° hjørneprofil
6002237	Montering dørfelt B30

Art.nr.6-2900010

TEGNINGER FOR BRANNKLASSET MONTERING

PRODUKT	VEGGTYPE	TEGNING NR.	DATO	REV.NR	REV.DATO
MV-100 Brannklassifisert	Glass og veggmodul, tilslutninger og sammenføyninger	6001858	140410	A	-
MV-100 Brannklassifisert	Glass og veggmodul, tilslutninger og sammenføyninger	6001859	140410	A	-
MV-100 Brannklassifisert	Montering av EI30 tettmodul	6001860	140410	A	-
MV-100 Brannklassifisert	V-Fas, tilsluttet EI30 tettmodul, med rammeprofil	6001855	240418	B	-
MV-100 Brannklassifisert	V-Fas, tilsluttet EI30 tettmodul, med U-kanal og avslutningslist	6001854	240418	B	-
MV-100 Brannklassifisert	Hatteprofil, tilsluttet EI30 tettmodul	6001850	240418	B	-
MV-100 Brannklassifisert	Montering av 90gr.hjørneprofil	6001468	130808	A	-
MV-100 Brannklassifisert	Montering av 45gr.hjørneprofil	6001520	130808	A	-
MV-100 Brannklassifisert	Montering B30 dørkarm	6002237	230522	B	-
-	-	-	-	-	-



DOKUMENTERING AV BRANNKLASSET MONTERING

PROSJEKT	MONTØRFIRMA	DATO	SIGN
-	-	-	-

EI30, BYGGEPLASSENS SJEKKLISTE

UTFØRENDE MONTØRFIRMA FOR MONTASJEN AV BRANNKLASSEDE PRODUKTER ER ANSVARLIGE FOR UTFYLLING OG SIGNERING AV EI30, BYGGEPLASSENS SJEKKLISTE FOR MONTERT IHT.GJELDENDE TEGNINGSUNDERLAG.

BYGGEPLASSENS SJEKKLISTE SKAL LEVERES SOM BYGGETS DOKUMENTASJON FOR MV-100 EI30, BRANNKLASSIFISERT

Skala 1:1	Tittel MV-100 Brannklassifisert	Tegnet av Rune L	Godkjent av Lars N
		Dato 10/10/2014	Rev dato 18/04/2024
	 MODULVEGGER	Tegning nr. 6002141	Rev nr. B
		A3 EI30, Byggeplassens sjekklister	

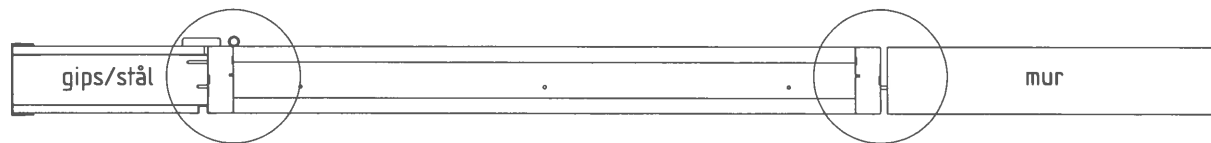
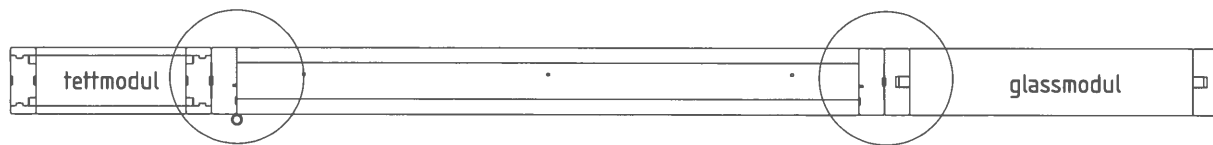

3x Ø 4.5 / Ø14 forsenk



6x Ø 4.5 / Ø14 forsenk

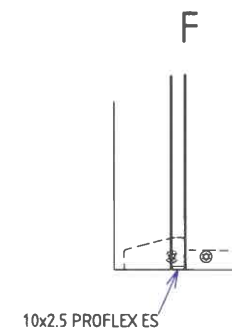
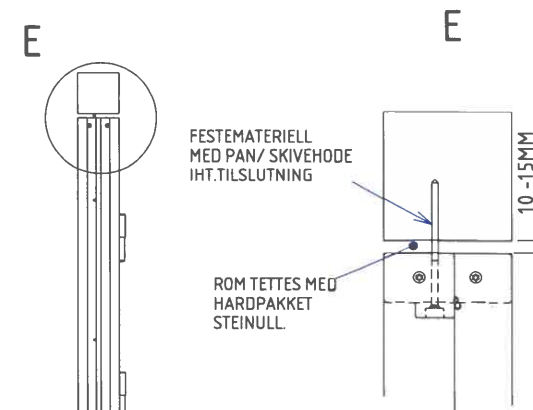
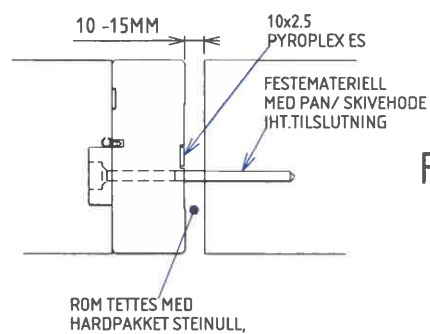
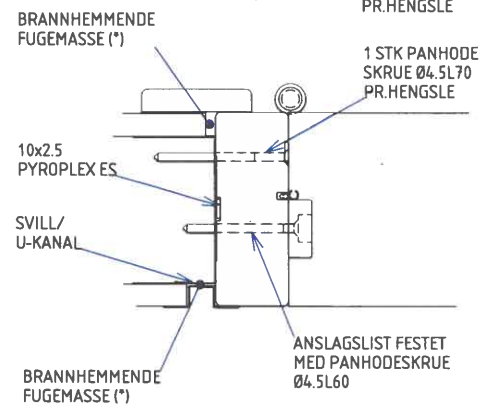
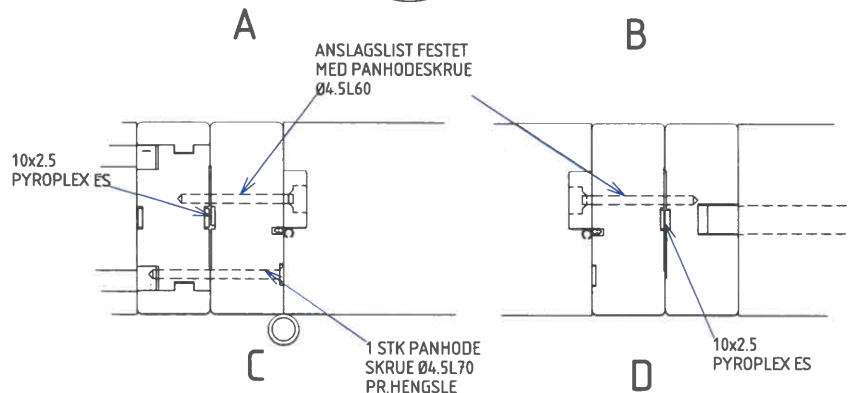
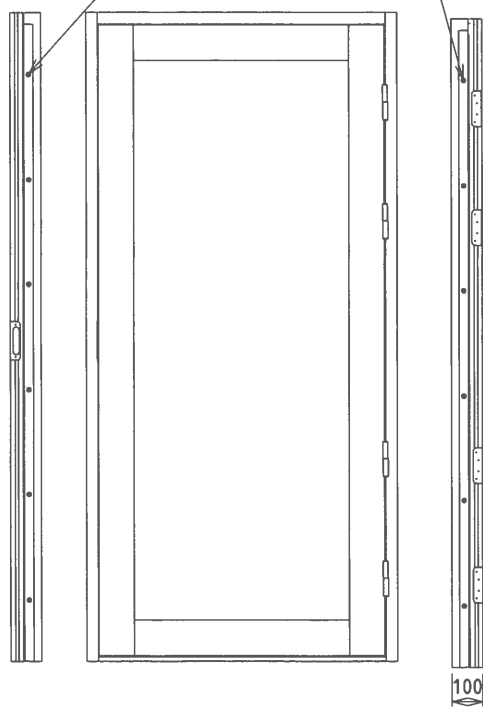

(*) GODKJENT BRANNHEMMEDE FUGEMASSE:

- 1) FIRECRYL FR
- 2) FIRESTOP 100
- 3) FIRESTOP 700

Skala	Tittel	Tegnet av	Godkjent av
1:10	MV-100 Brannklassifisert	Rune L	Lars N
		Dato	Revidert dato
		22/12/2014	22/05/2023
		Tegningsnummer	Rev. nr.
		6002237	B
A3	DØRMODUL B.30, MONTERT MOT TILSLUTNINGER	Toleranse	-

TILSLUTNINGER: BETONG- GIPS/ STÅL

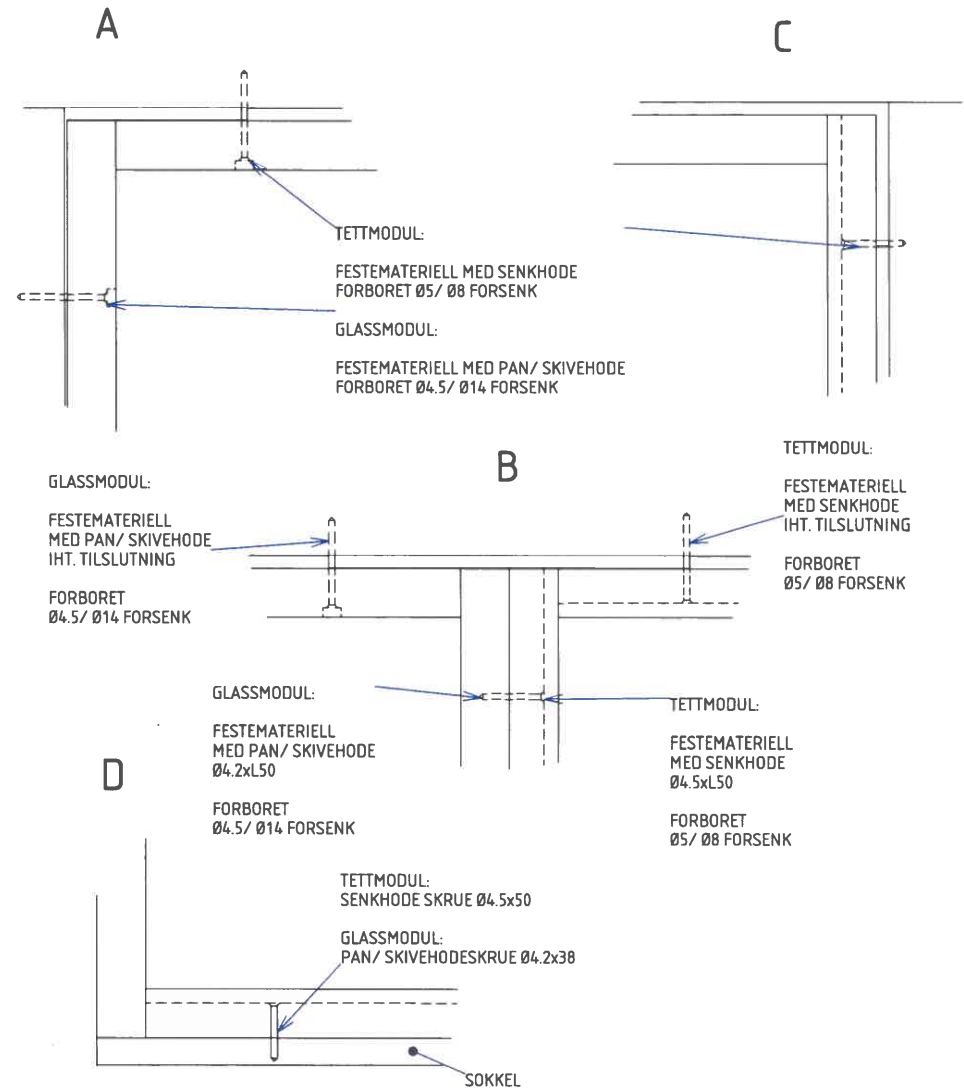
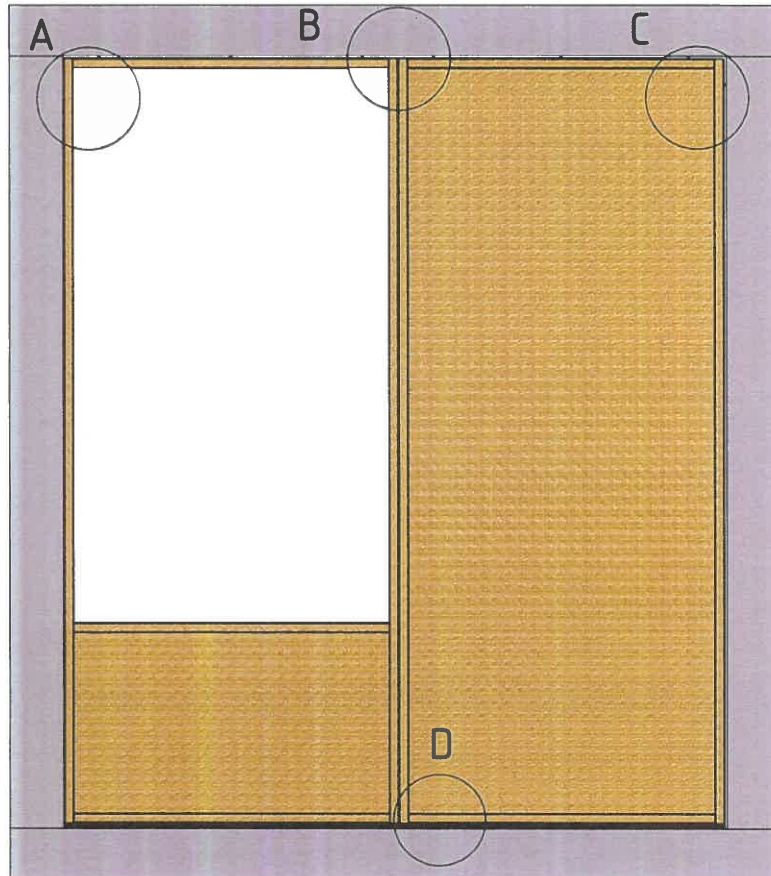

Skala	Tittel	Tegnet av	Godkjent av
1:20	MV-100 Brannklassifisert	Rune L	Lars N
		Dato	Revidert dato
		10/04/2014	00/00/0000
	MODULVEGGER	Tegningsnummer	Rev. nr.
		6001858	A
A3	GLASS OG TETTMODUL, TILSLUTNINGER OG SAMMENFØYNINGER	Toleranse	-

TILSLUTNINGER: BETONG- GIPS/ STÅL

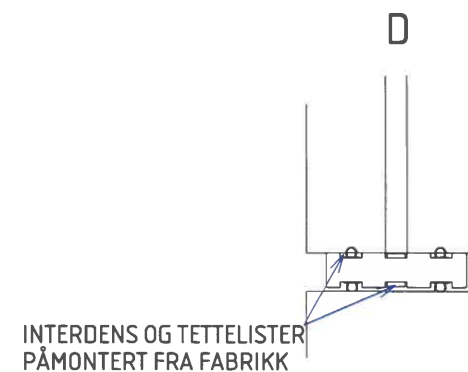
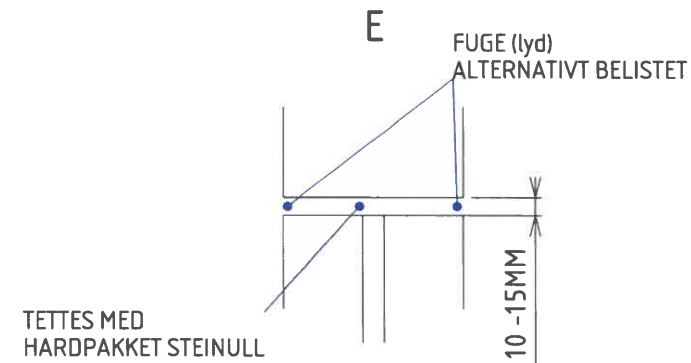
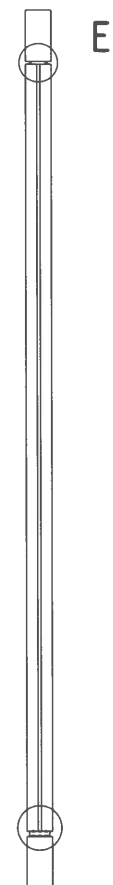
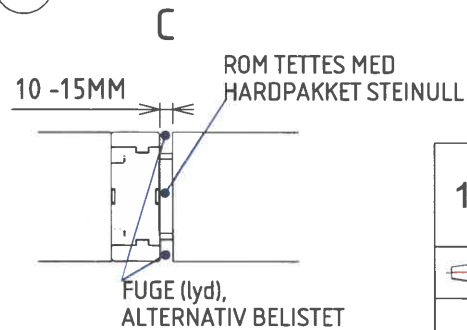
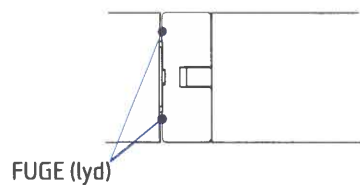
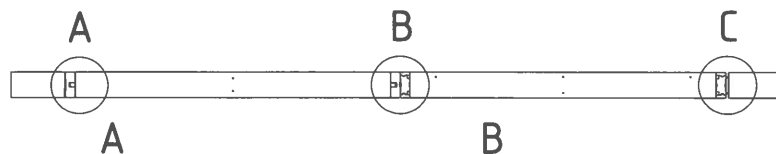
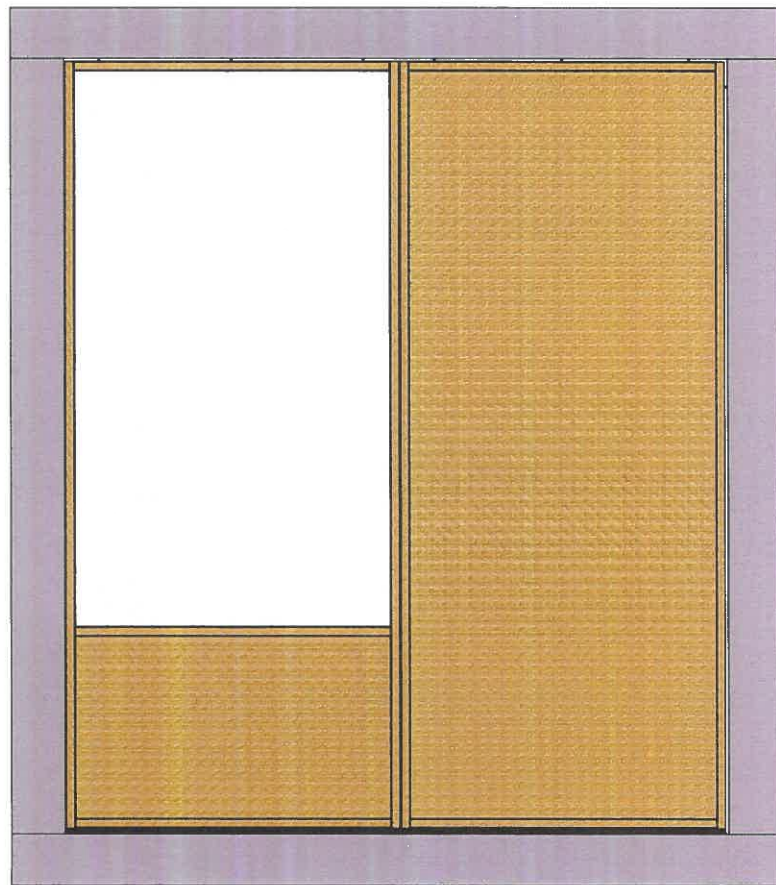

Skala 1:20	Tittel MV-100 Brannklassifisert	Tegnet av Rune L	Godkjent av Lars N
		Dato 10/04/2014	Revidert dato 00/00/0000
		Tegningsnummer 6001859	Rev. nr. A
		Toleranse -	
A3	GLASS OG TETTMODUL, TILSLUTNINGER OG SAMMENFØYNINGER		

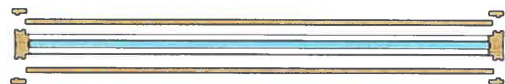
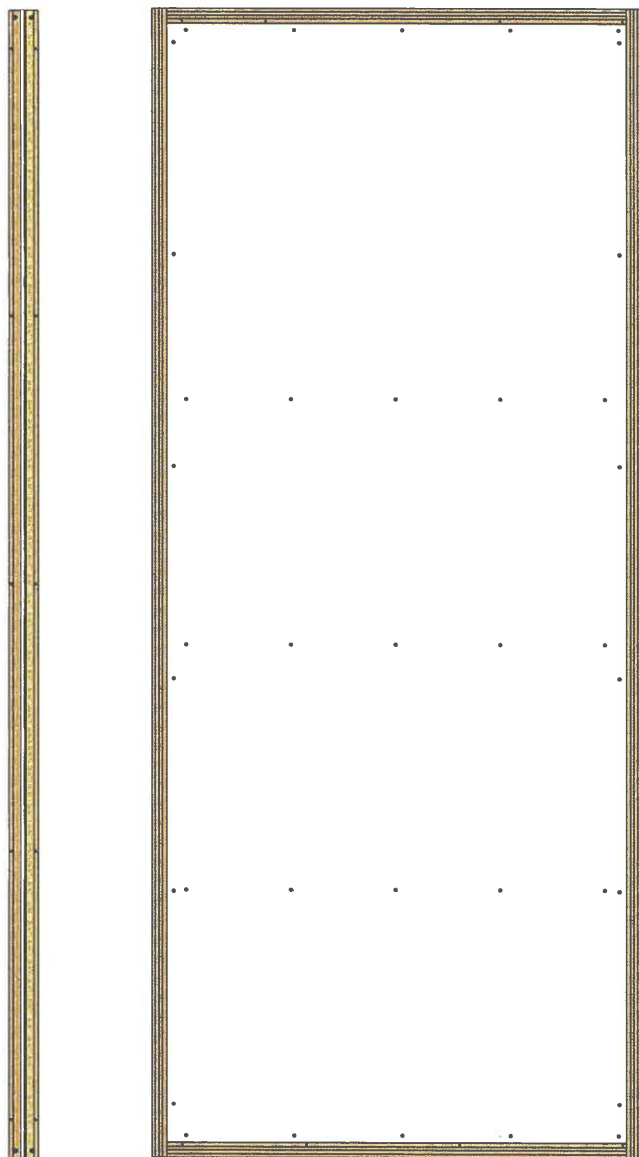

A

B

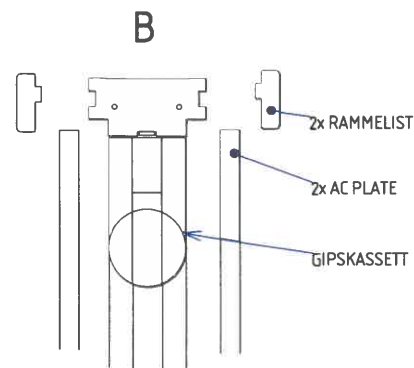

TILSLUTNINGER:

FUGE (LYD)
ALTERNATIVT BELISTET

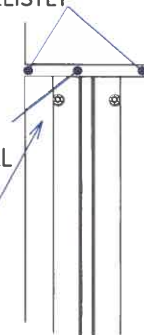

ROM TETTES MED
HARDPAKKET STEINULL

FORBORET
Ø5/ Ø8 FORSENK

SOKKEL LEVERES MED
PÅMONTORTE INTEDENS
OG TETTELISTER

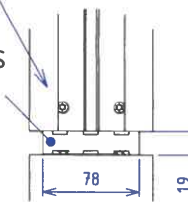

MONTERING:

MODUL LEVERES ISOLERT MED ROCKWOOL, PÅMONTORTE GIPSPLATER OG INTERDENS LISTER FOR VERTIKALE STOLPER.

DET ER IKKE NØDVENDIG MED BRUK AV BRANNHEMMENDE FUGEMASSE FOR FOR VERTIKALE SAMMENFØYNINGER MELLOM MODULER.

MODUL MONTERES MOT TILSLUTNINGER I FORBOREDE FORSENKEDE HULL Ø5MM.

TILPASSEDE AC PLATER OG RAMMELISTER MEDLEVERES LØST.

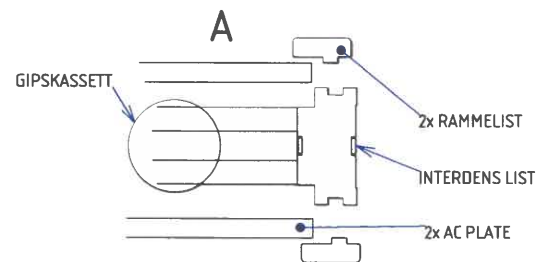

AC PLATER MONTERES MED SENSKRUE Ø3.9xL30 I FORBOREDE/ FORSENKEDE HULL.

RAMMELISTER STIFTES PÅ MED 40MM DYKKERTSPIKER.



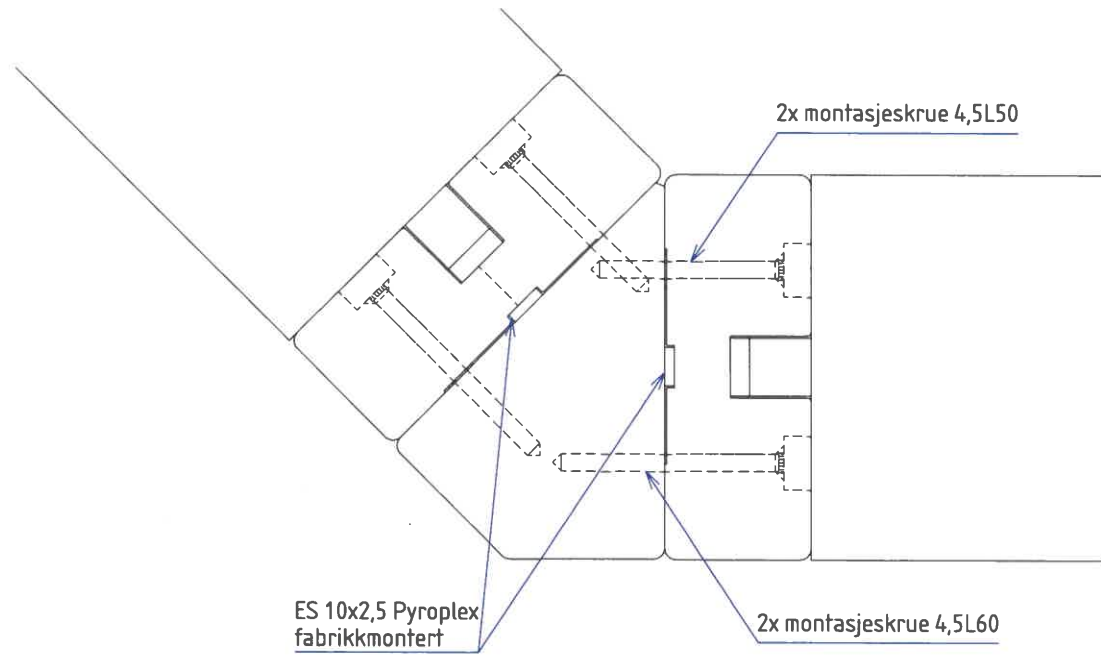
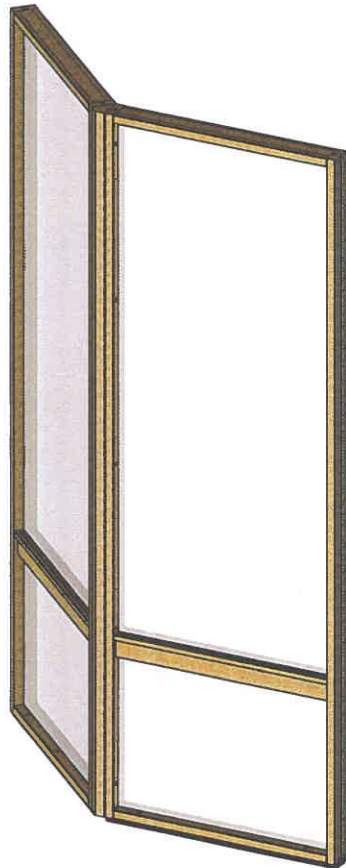

Skala	Tittel	Tegnet av	Godkjent av
1:20	MV-100 Brannklassifisert	Rune L	Lars N
		Dato	Revidert dato
		14/04/2014	00/00/0000
	 MODULVEGGER	Tegningsnummer	Rev. nr.
		6001860	A
A3	MONTERING AV EI30 TETTMODUL	Toleranse	-

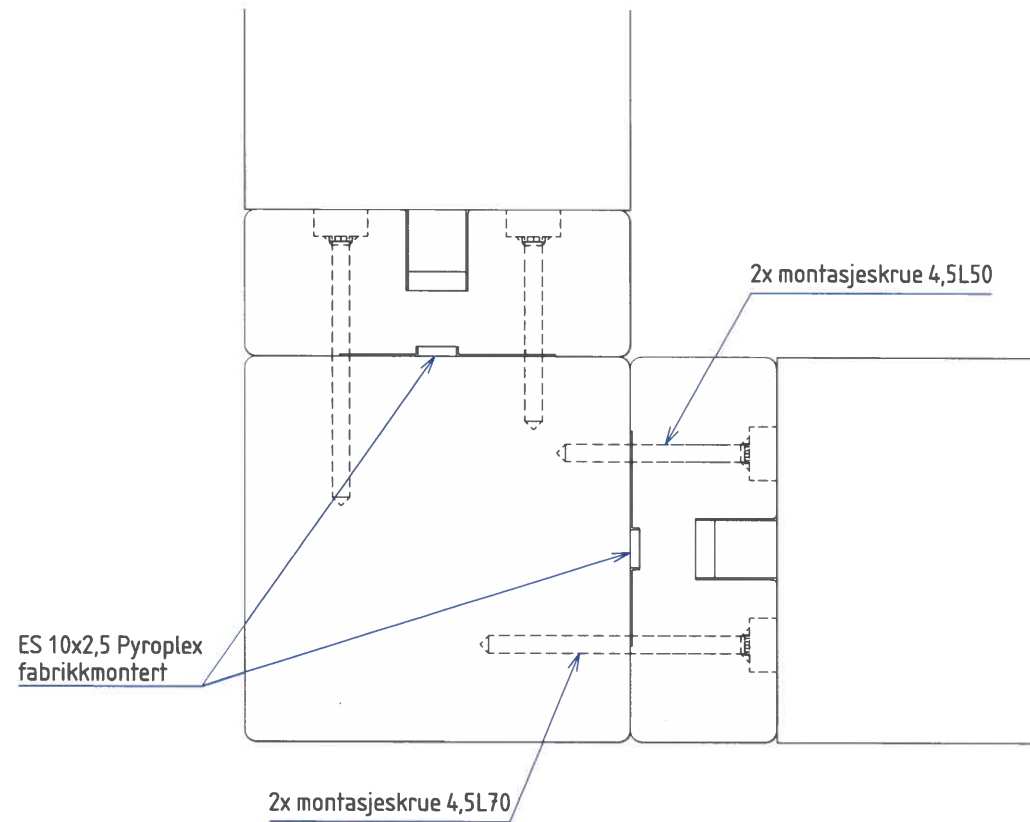
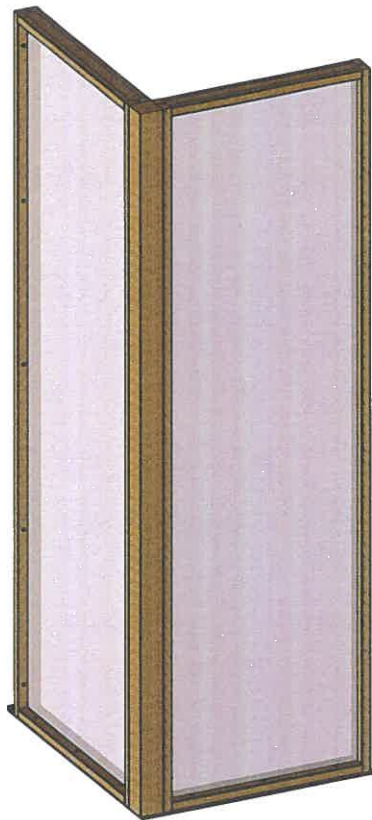

Skala	Tittel	Tegnet av	Godkjent av
1:20	MV-100 Brannklassifisert	Rune L	Lars N
		Dato	Revidert dato
		08/08/2013	00/00/0000
	 MODULVEGGER	Tegningsnummer	Rev. nr.
A3	45 GRADER HJØRNE MONTERT I FELT	6001520	A
		Toleranse	-



Skala	Tittel	Tegnet av	Godkjent av
1:20	MV-100 Brannklassifisert	Rune L	Lars N
		Dato	Revidert dato
		08/08/2013	00/00/0000
		Tegningsnummer	Rev. nr.
A3	90 GRADER HJØRNE MONTERT I FELT	6001468	A
		Toleranse	-

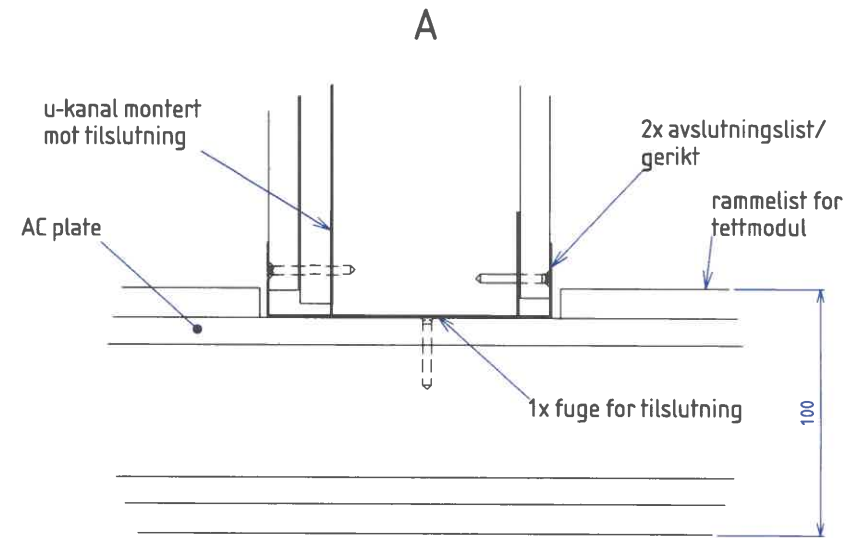
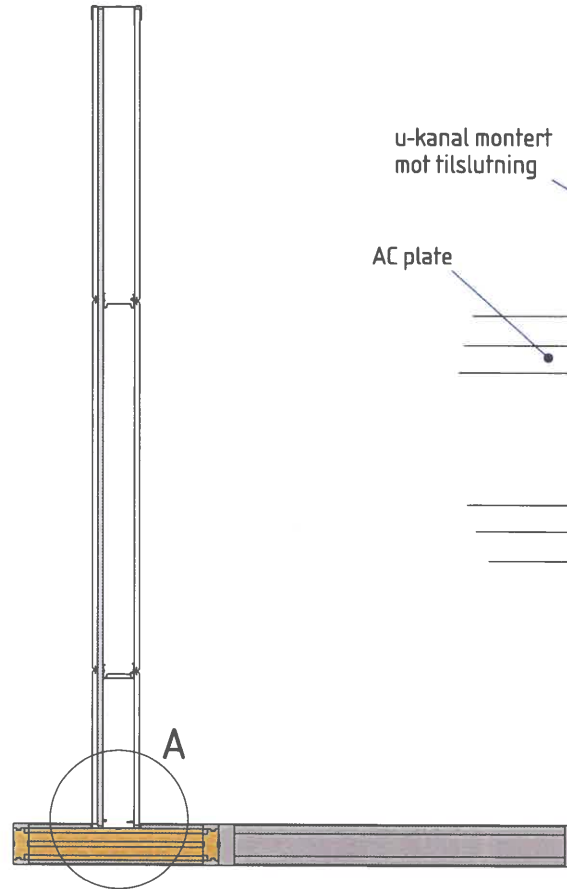
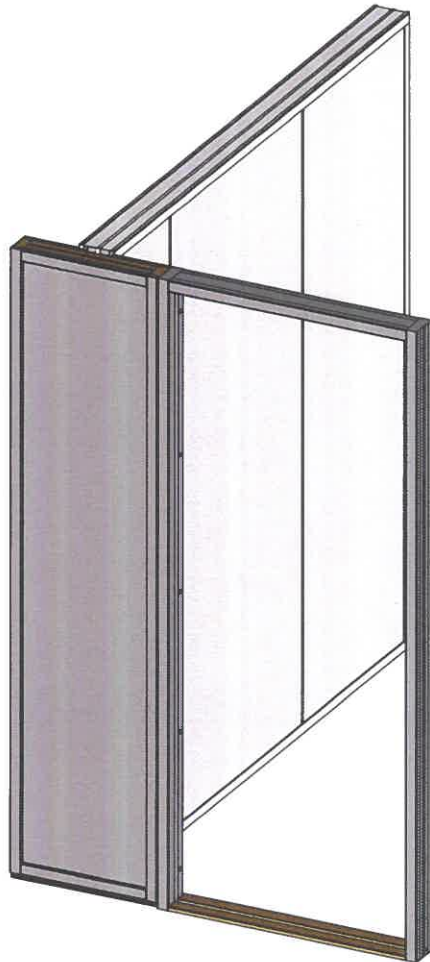

Skala	Tittel	Tegnet av	Godkjent av
1:10	MV-100 Brannklassifisert	Rune L	Lars N
		Dato	Revidert dato
		09/04/2014	18/04/2024
		Tegningsnummer	Rev. nr.
A3	V-FAS VEGG MONTERT MOT EI30 TETTMODUL MED U-KANAL	6001854	B
		Toleranse	-

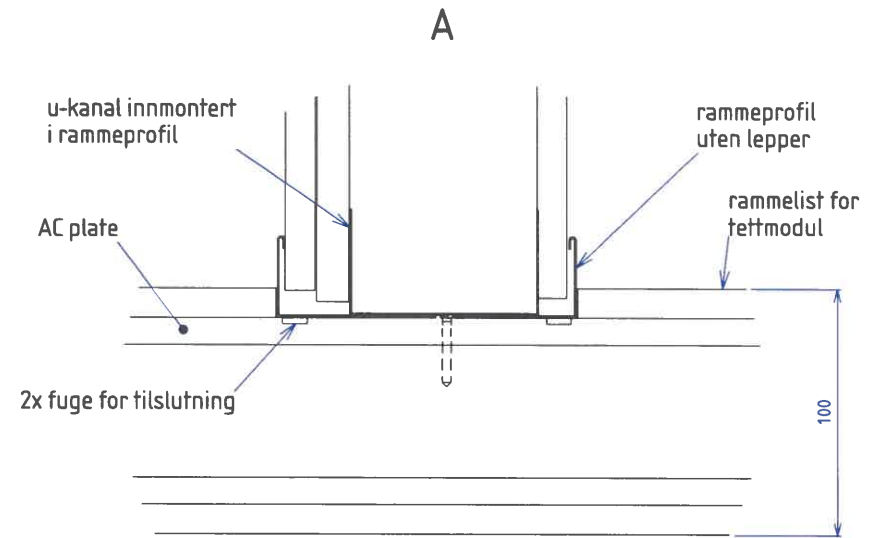
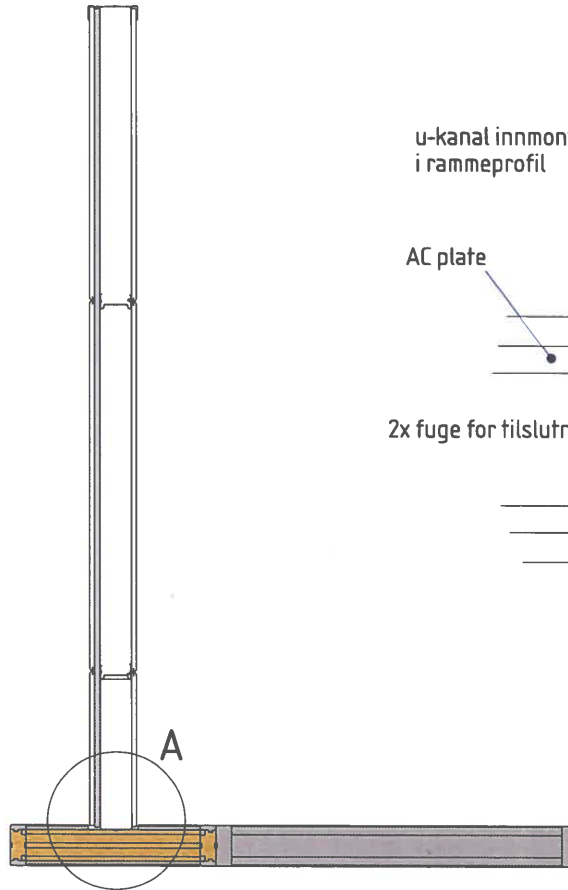
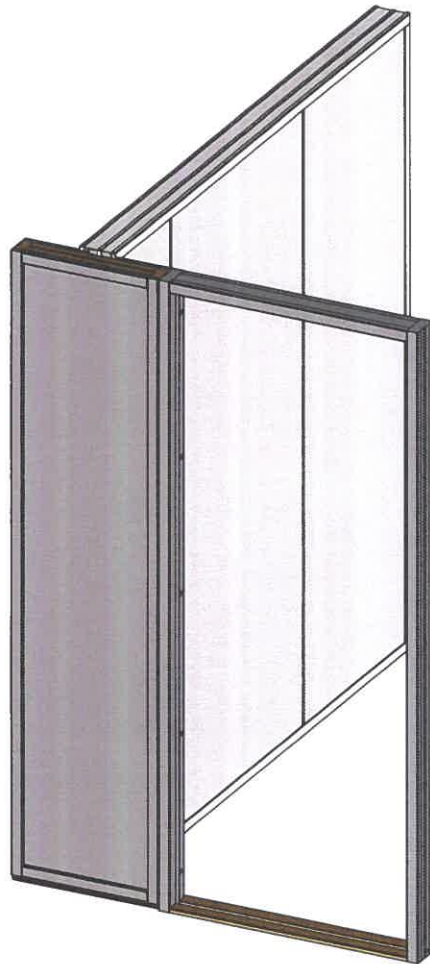

Skala 1:10	Tittel MV-100 Brannklassifisert	Tegnet av Rune L	Godkjent av Lars N
		Dato 10/04/2014	Revidert dato 18/04/2024
A3		Tegningsnummer 6001855	Rev. nr. B
		Toleranse -	

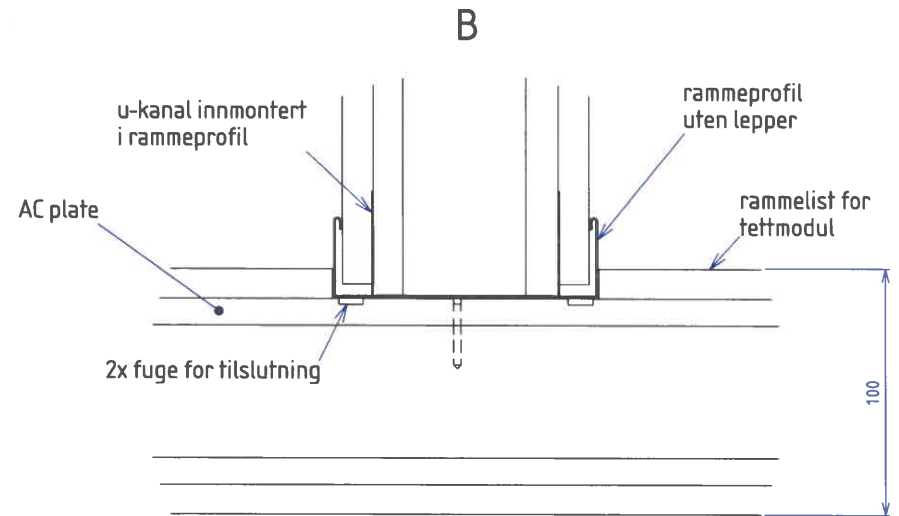
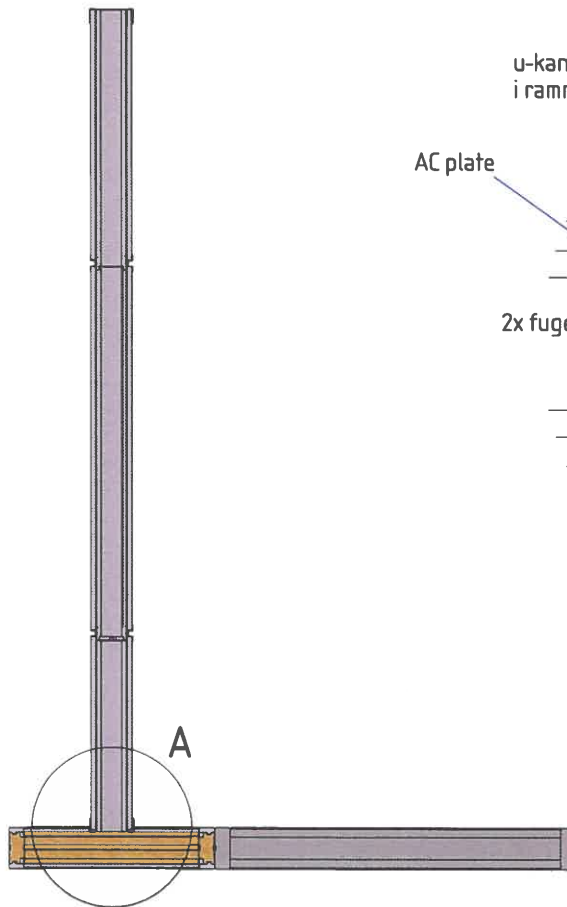
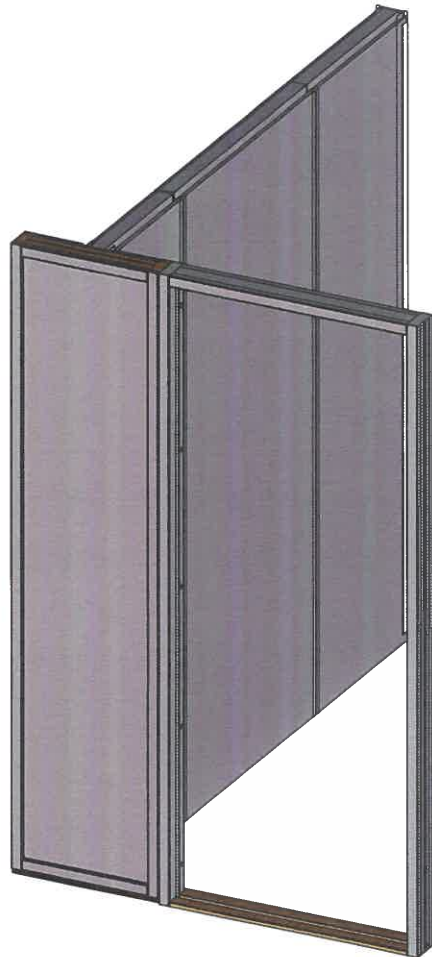

Skala 1:10	Tittel MV-100 Brannklassifisert	Tegnet av Rune L	Godkjent av Lars N
		Dato 07/04/2014	Revidert dato 18/04/2024
A3	 MODULVEGGER	Tegningsnummer 6001850	Rev. nr. B
		Toleranse -	