



Montasjeanvisninger:

## MV-Brannklassifisert EW30

Tegn.nr

6004129	EW30-Byggeplassens sjekklister
6001858	Glass og veggmodul, tilslutninger og sammenføyninger
6001859	Glass og veggmodul, tilslutninger og sammenføyninger
6001860	Montering EI30 tettmodul
6001855	V-Fas montert med rammeprofil- tilsluttet EI30 tettmodul
6001854	V-Fas montert med U. svill- tilsluttet EI30 tettmodul
6001850	Hatteprofil med rammeprofil-tilsluttet EI30 tettmodul
6001468	Montering glassfelt EW30- 90° hjørneprofil
6001520	Montering glassfelt EW30- 45° hjørneprofil
6002237	Montering dørfelt B30

Art.nr.6-2900016

## TEGNINGER FOR BRANNKLASSET MONTERING

PRODUKT	VEGGTYPE	TEGNING NR.	DATO	REV.NR	REV.DATO
MV-100 Brannklassifisert	Glass og veggmodul, tilslutninger og sammenføyninger	6001858	140410	A	-
MV-100 Brannklassifisert	Glass og veggmodul, tilslutninger og sammenføyninger	6001859	140410	A	-
MV-100 Brannklassifisert	Montering av EI30 tettmodul	6001860	140410	A	-
MV-100 Brannklassifisert	V-Fas, tilsluttet EI30 tettmodul, med rammeprofil	6001855	240418	B	-
MV-100 Brannklassifisert	V-Fas, tilsluttet EI30 tettmodul, med U-kanal og avslutningslist	6001854	240418	B	-
MV-100 Brannklassifisert	Halteprofil, tilsluttet EI30 tettmodul	6001850	140407	B	-
MV-100 Brannklassifisert	Montering av 90gr.hjørneprofil	6001468	130808	A	-
MV-100 Brannklassifisert	Montering av 45gr.hjørneprofil	6001520	130808	A	-
MV-100 Brannklassifisert	Montering B30 dørkarm	6002237	230522	B	-
-	-	-	-	-	-



## DOKUMENTERING AV BRANNKLASSET MONTERING

PROSJEKT	MONTØRFIRMA	DATO	SIGN
-	-	-	-

### EW30, BYGGEPLASSENS SJEKKLISTE

UTFØRENDE MONTØRFIRMA FOR MONTASJEN AV BRANNKLASSEDE PRODUKTER ER ANSVARLIGE FOR UTFYLLING OG SIGNERING AV EW30, BYGGEPLASSENS SJEKKLISTE FOR MONTERT IHT.GJELDENE TEGNINGSUNDERLAG.

BYGGEPLASSENS SJEKKLISTE SKAL LEVERES SOM BYGGETS DOKUMENTASJON FOR MV-100 EW30, BRANNKLASSIFISERT

Skala <b>1:1</b>	Tittel <b>MV-100 Brannklassifisert</b>	Tegnet av <b>Rune L</b>	Godkjent av <b>Lars N</b>
		Dato <b>08/10/2018</b>	Rev dato <b>18/04/2024</b>
	 <b>MODULVEGGER</b>	Tegning nr. <b>6004129</b>	Rev nr. <b>B</b>
		<b>A3</b>	<b>EW30, Byggeplassens sjekklister</b>
			Toleranse <b>-</b>

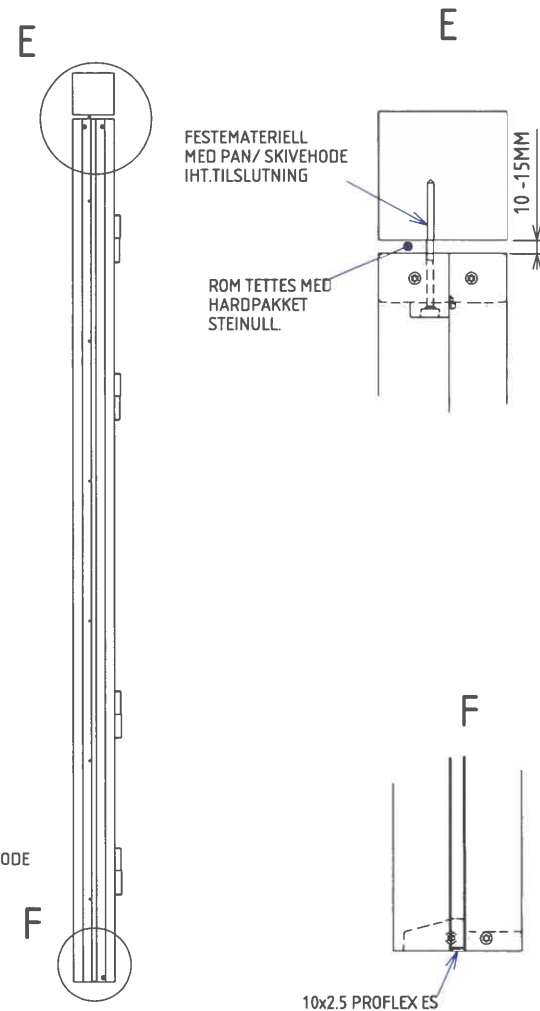
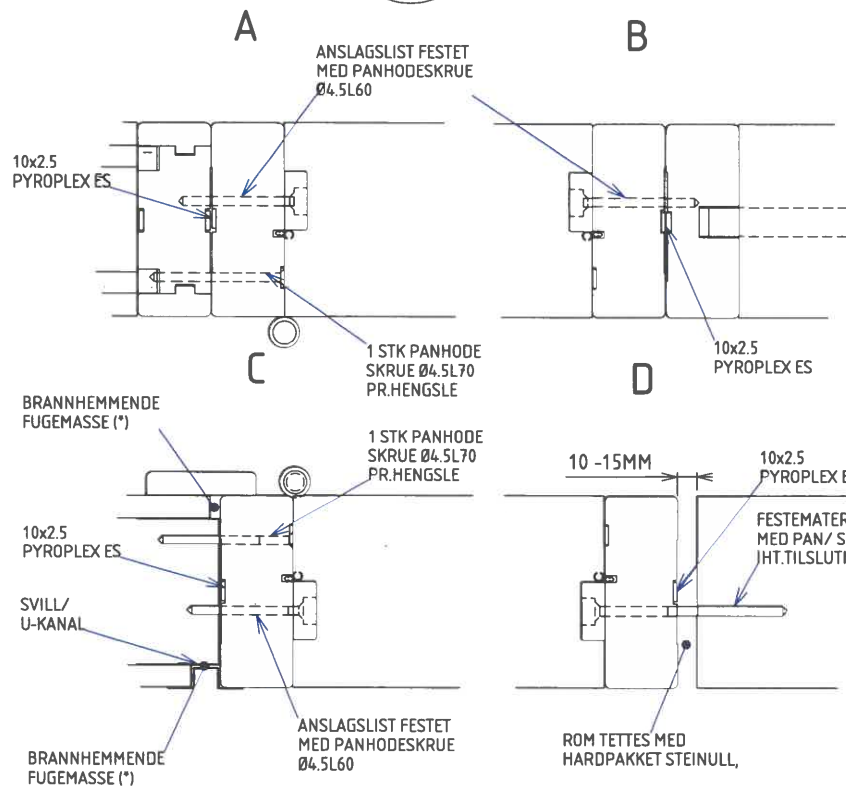
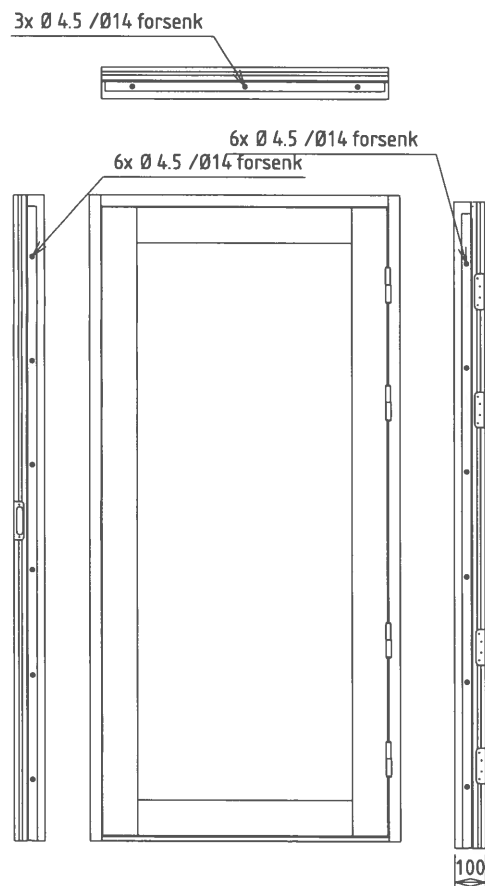
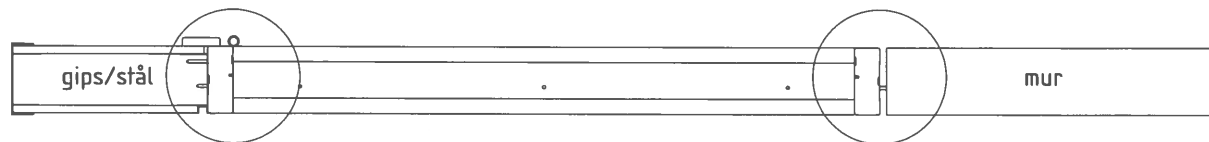
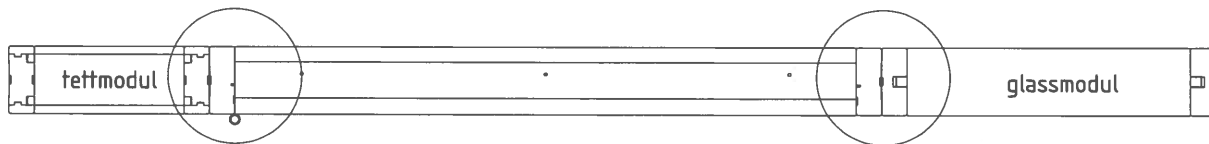

(\*) GODKJENT BRANNHEMMEDE FUGEMASSE:

- 1) FIRECRYL FR
- 2) FIRESTOP 100
- 3) FIRESTOP 700

Skala	Tittel	Tegnet av	Godkjent av
1:10	MV-100 Brannklassifisert	Rune L	Lars N
		Dato	Revidert dato
		22/12/2014	22/05/2023
		Tegningsnummer	Rev. nr.
		6002237	B
A3	DØRMODUL B.30, MONTERT MOT TILSLUTNINGER	Toleranse	-

TILSLUTNINGER: BETONG- GIPS/ STÅL

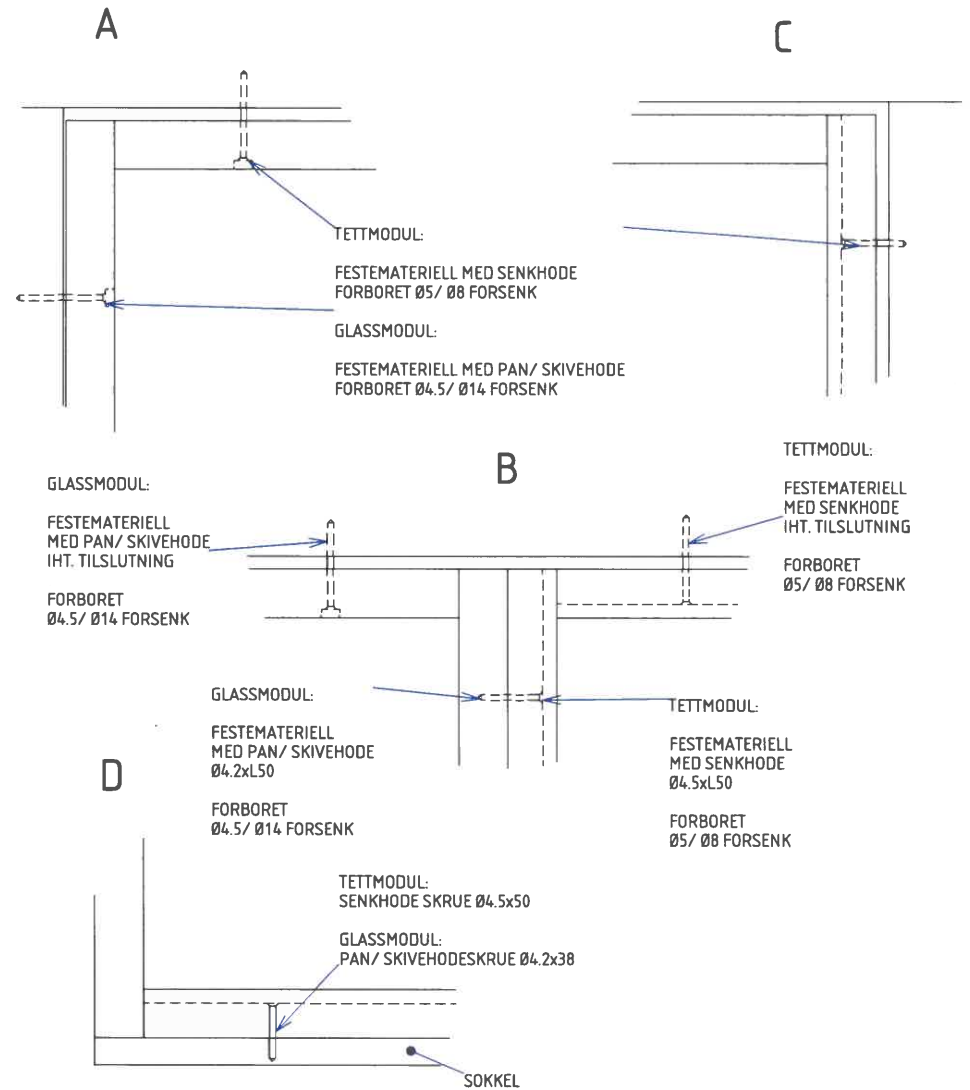
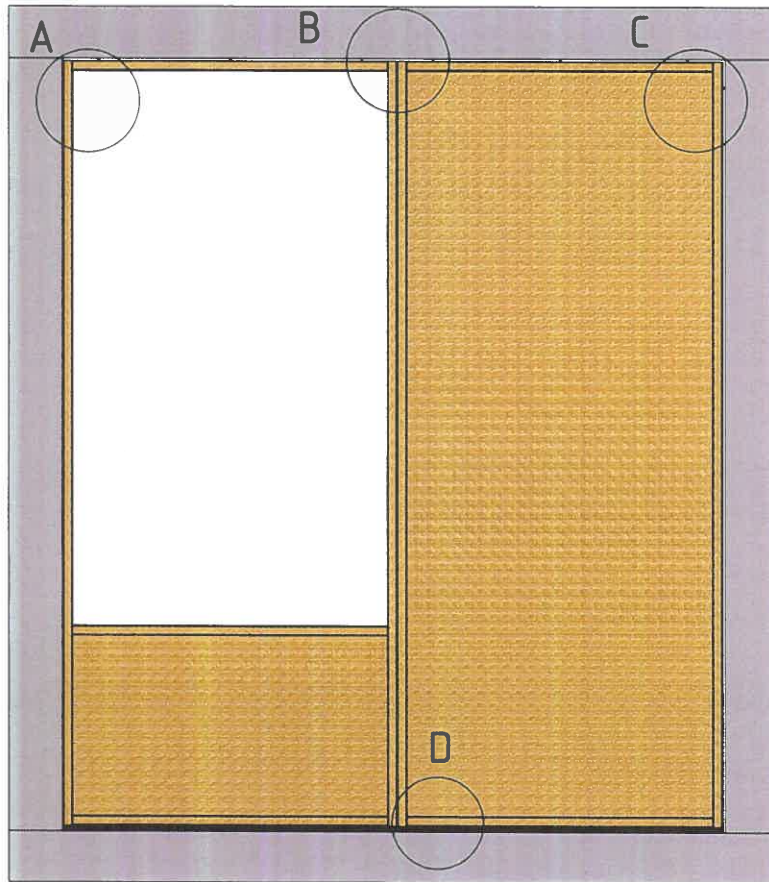

Skala <b>1:20</b>	Tittel <b>MV-100 Brannklassifisert</b>	Tegnet av <b>Rune L</b>	Godkjent av <b>Lars N</b>
		Dato <b>10/04/2014</b>	Revidert dato <b>00/00/0000</b>
		Tegningsnummer <b>6001858</b>	Rev. nr. <b>A</b>
<b>A3</b>	GLASS OG TETTMODUL, TILSLUTNINGER OG SAMMENFØYNINGER		Toleranse <b>-</b>

TILSLUTNINGER: BETONG- GIPS/ STÅL

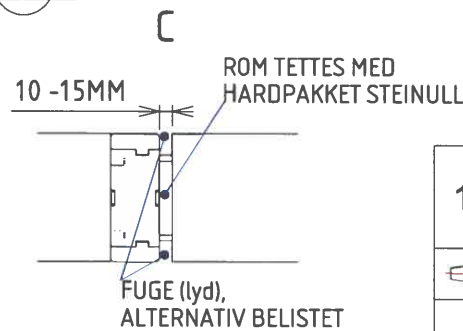
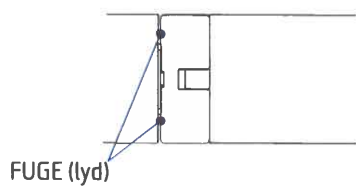
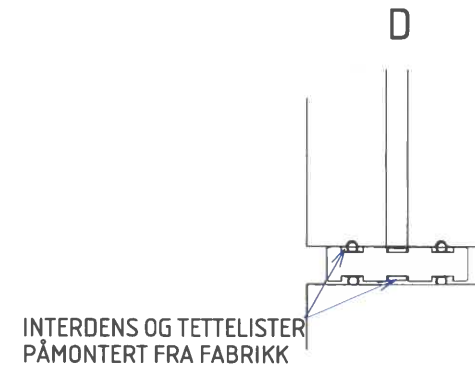
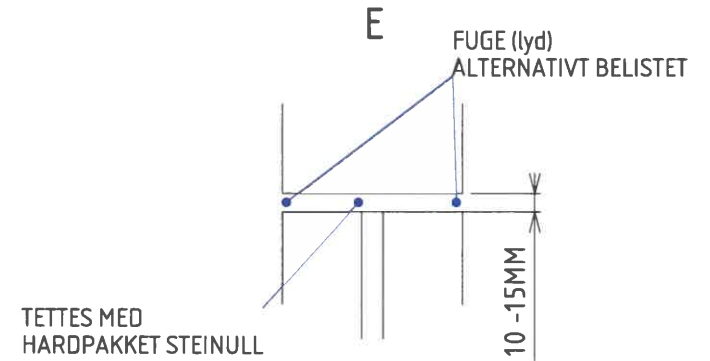
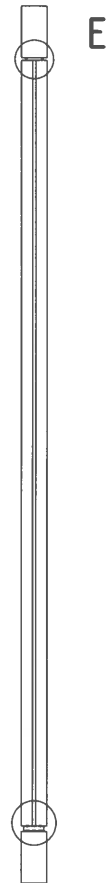
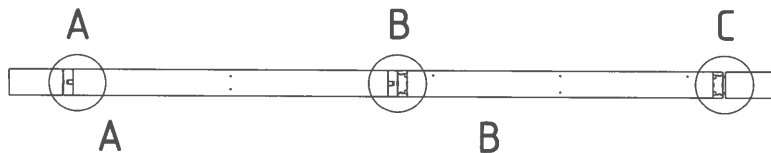
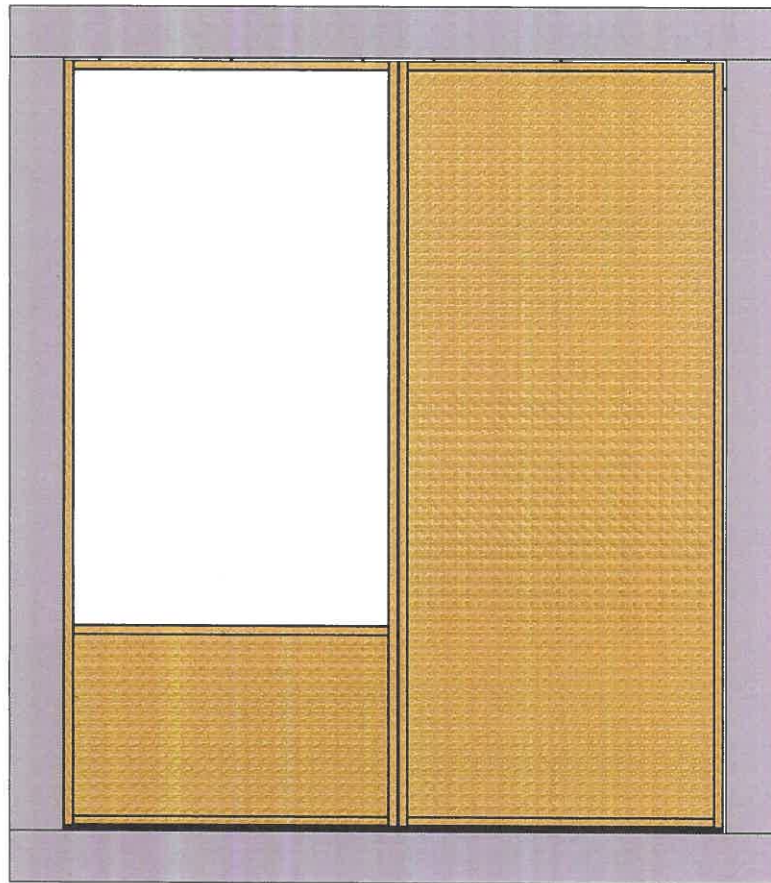

Skala <b>1:20</b>	Tittel <b>MV-100 Brannklassifisert</b>	Tegnet av <b>Rune L</b>	Godkjent av <b>Lars N</b>
		Dato <b>10/04/2014</b>	Revidert dato <b>00/00/0000</b>
<b>A3</b>	 <b>MODULVEGGER</b>	Tegningsnummer <b>6001859</b>	Rev. nr. <b>A</b>
	GLASS OG TETTMODUL, TILSLUTNINGER OG SAMMENFØYNINGER		Toleranse <b>-</b>

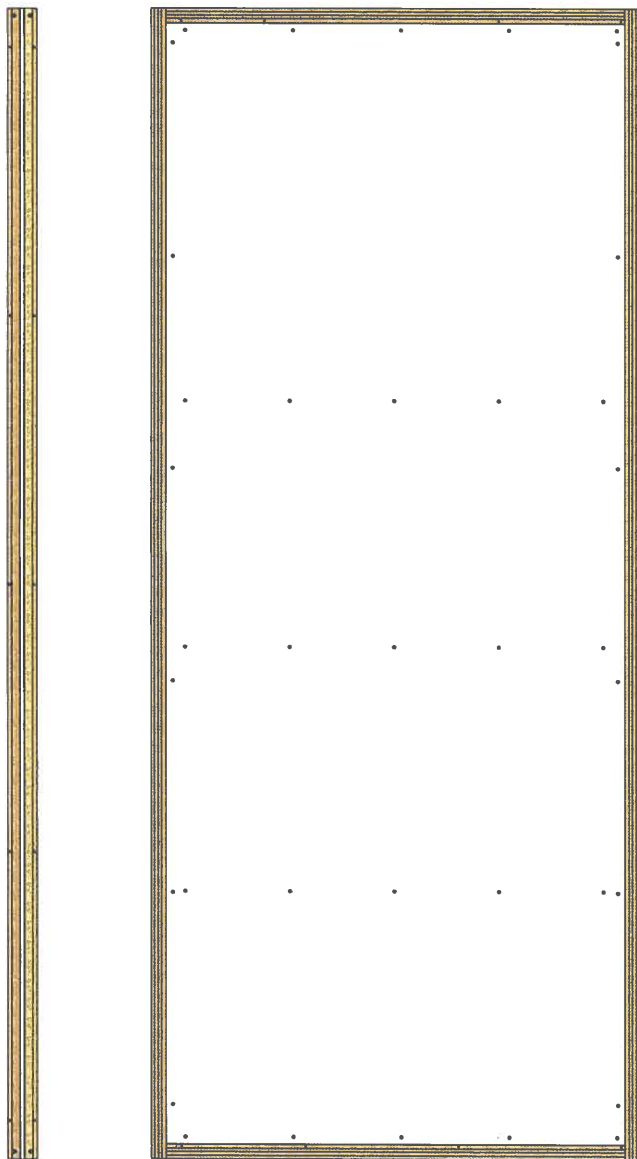

A

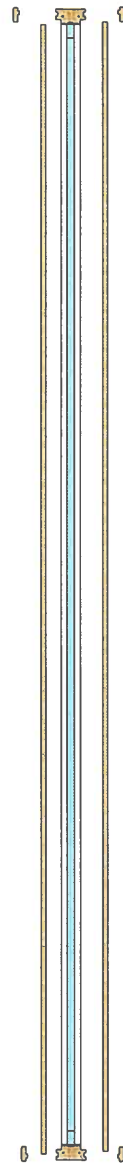
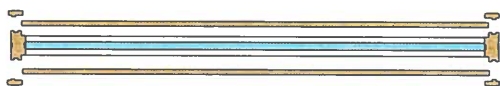

B

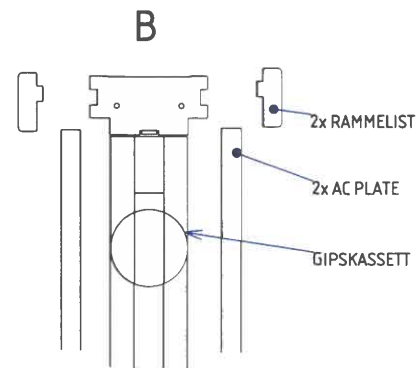

TILSLUTNINGER:

FUGE (LYD)  
ALTERNATIVT BELISTET

ROM TETTES MED  
HARDEPÅKKT STEINULL

FORBORET  
Ø5/ Ø8 FORSENK

SØKKEL LEVERES MED  
PÅMONTERTE INTEDENS  
OG TETTELISTER

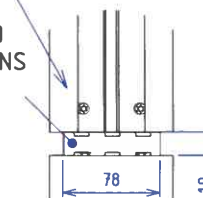
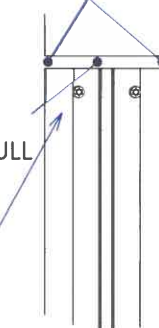

**MONTERING:**

MODUL LEVERES ISOLERT MED ROCKWOOL, PÅMONTERTE GIPSPLATER OG INTERDENS LISTER FOR VERTIKALE STOLPER.

DET ER IKKE NØDVENDIG MED BRUK AV BRANNHEMMENDE FUGEMASSE FOR VERTIKALE SAMMENFØYNINGER MELLOM MODULER.

MODUL MONTERES MOT TILSLUTNINGER I FORBOREDE FORSENKEDE HULL Ø5MM.

TILPASSEDE AC PLATER OG RAMMELISTER MEDLEVERES LØST.

AC PLATER MONTERES MED SENKSKRUE Ø3.9xL30 I FORBOREDE/ FORSENKEDE HULL

RAMMELISTER STIFTES PÅ MED 40MM DYKKERTSPIKER.

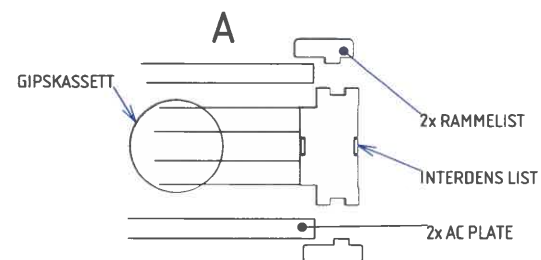

Skala <b>1:20</b>	Tittel <b>MV-100 Brannklassifisert</b>	Tegnet av <b>Rune L</b>	Godkjent av <b>Lars N</b>
		Dato <b>14/04/2014</b>	Revidert dato <b>00/00/0000</b>
	<b>MODULVEGGER</b>	Tegningsnummer <b>6001860</b>	Rev. nr. <b>A</b>
<b>A3</b>	<b>MONTERING AV EI30 TETTMODUL</b>	Toleranse <b>-</b>	

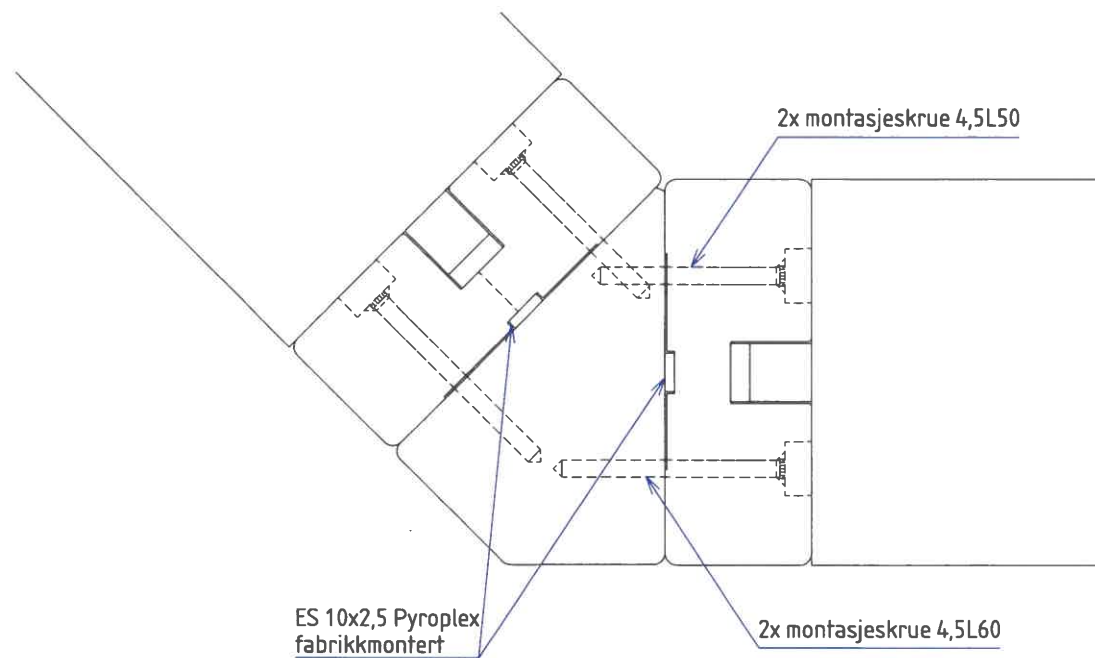
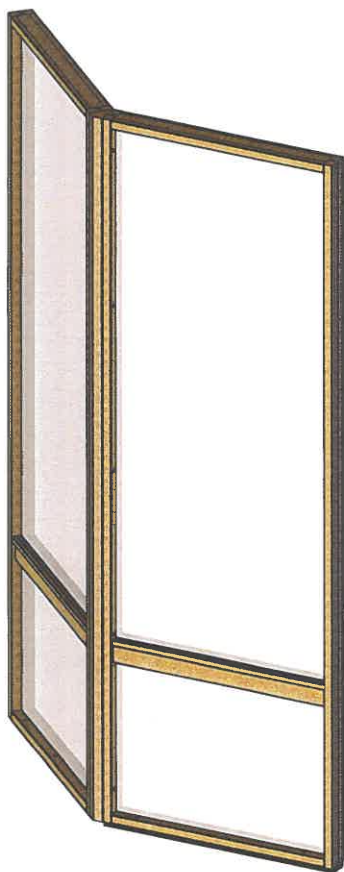

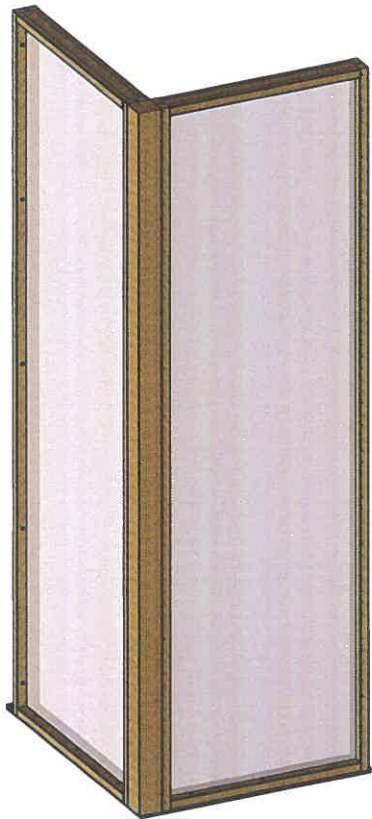

Skala	Tittel	Tegnet av	Godkjent av
1:20	MV-100 Brannklassifisert	Rune L	Lars N
		Dato	Revidert dato
		08/08/2013	00/00/0000
	 <b>MODULVEGGER</b>	Tegningsnummer	Rev. nr.
A3	45 GRADER HJØRNE MONTERT I FELT	6001520	A
		Toleranse	-

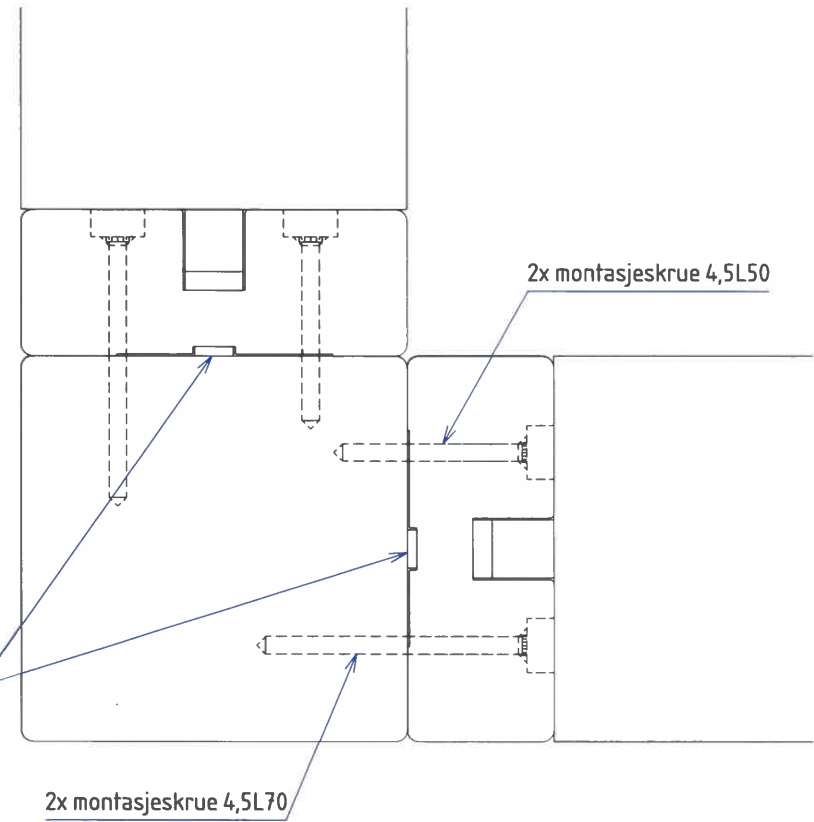

ES 10x2,5 Pyroplex  
fabrikkmontert



Skala	Tittel	Tegnet av	Godkjent av
1:20	MV-100 Brannklassifisert	Rune L	Lars N
		Dato	Revidert dato
		08/08/2013	00/00/0000
	 <b>MODULVEGGER</b>	Tegningsnummer	Rev. nr.
A3	90 GRADER HJØRNE MONTERT I FELT	6001468	A
		Toleranse	-



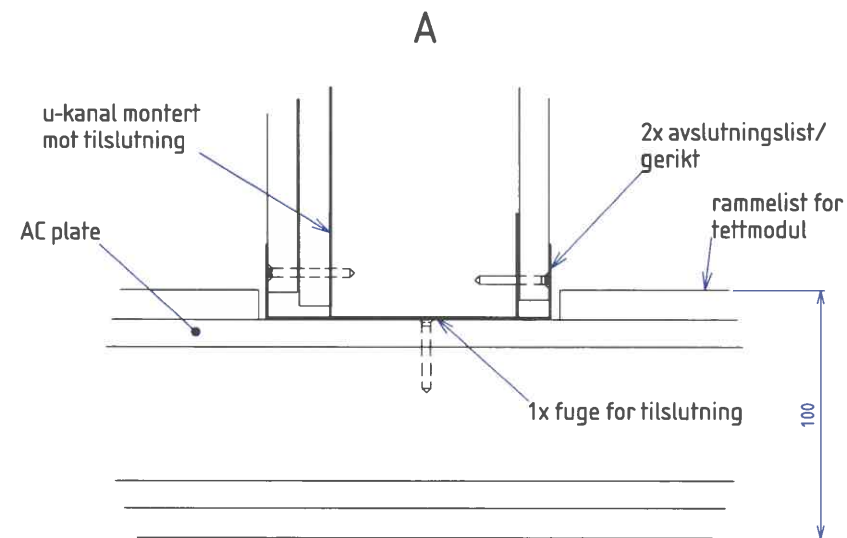
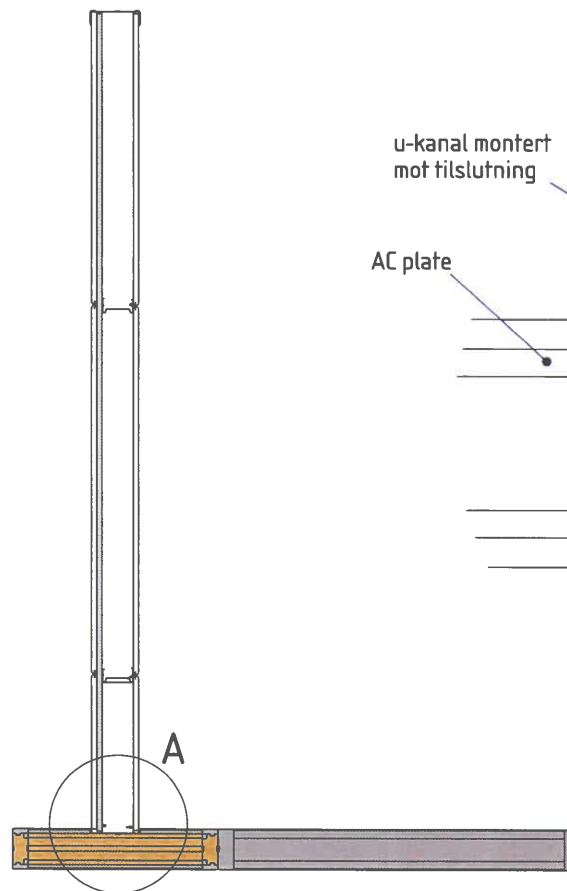
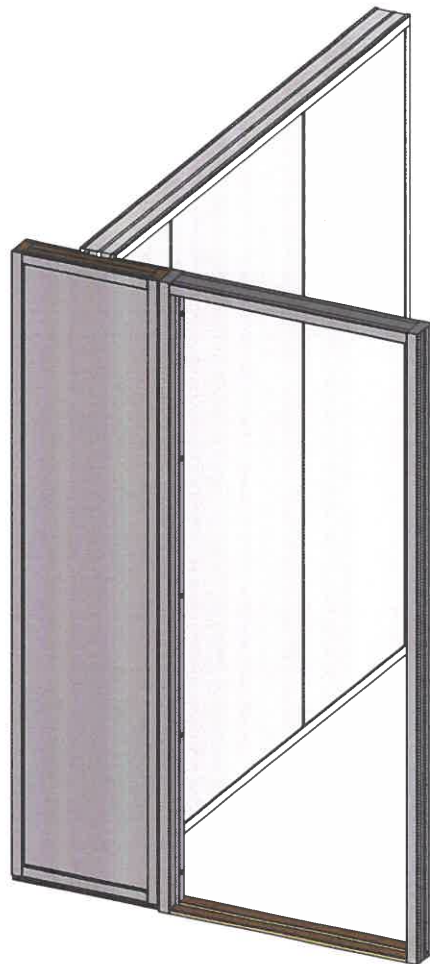

Skala <b>1:10</b>	Tittel <b>MV-100 Brannklassifisert</b>	Tegnet av <b>Rune L</b>	Godkjent av <b>Lars N</b>
		Dato <b>09/04/2014</b>	Revidert dato <b>18/04/2024</b>
		Tegningsnummer <b>6001854</b>	Rev. nr. <b>B</b>
<b>A3</b>	V-FAS VEGG MONTERT MOT EI30 TETTMODUL MED U-KANAL		Toleranse <b>-</b>

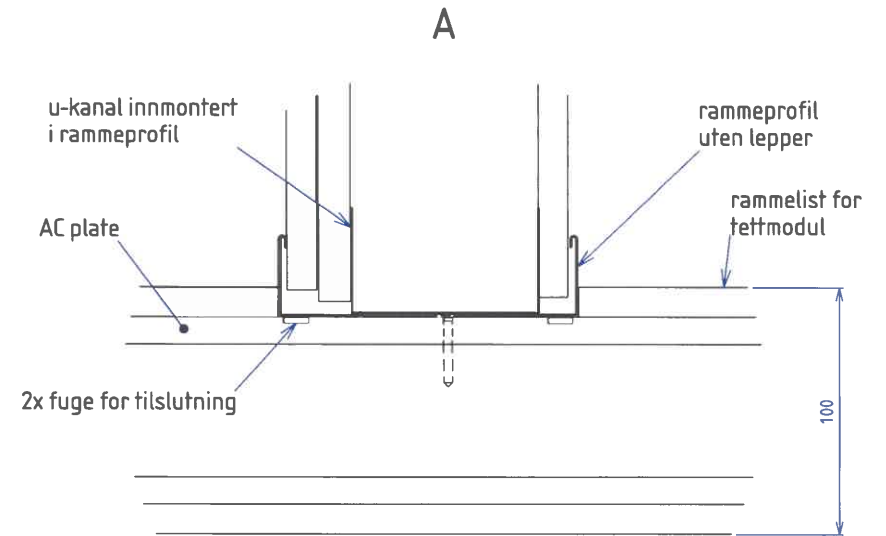
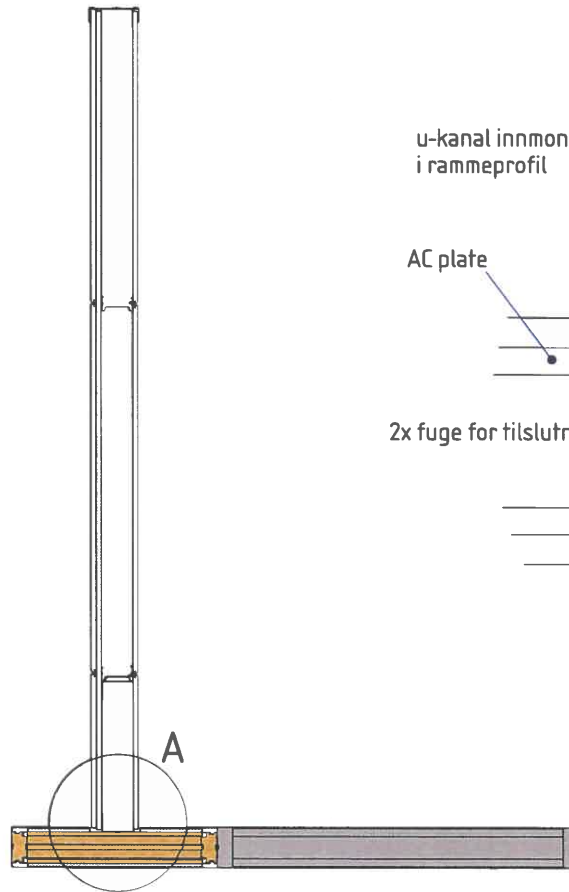
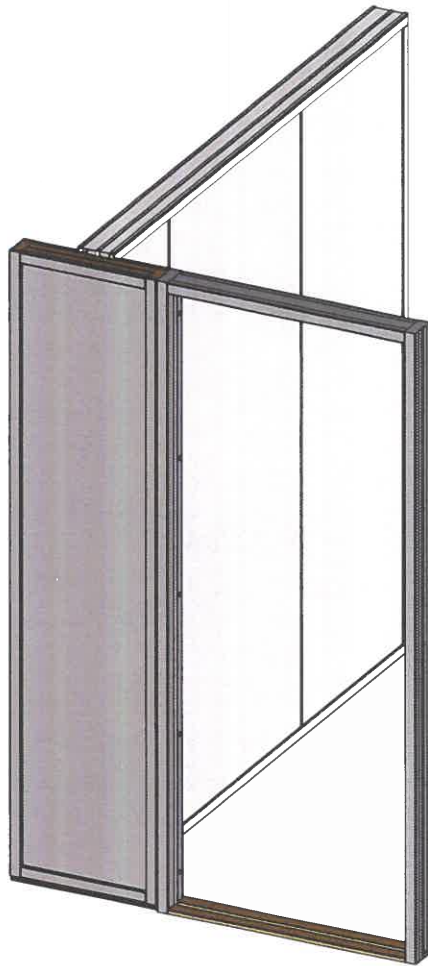

Skala <b>1:10</b>	Tittel <b>MV-100 Brannklassifisert</b>	Tegnet av Rune L	Godkjent av Lars N
		Dato 10/04/2014	Revidert dato 18/04/2024
		Tegningsnummer 6001855	Rev. nr. B
		<b>A3</b>	V-FAS VEGG MONTERT MOT E130 TETTMODUL

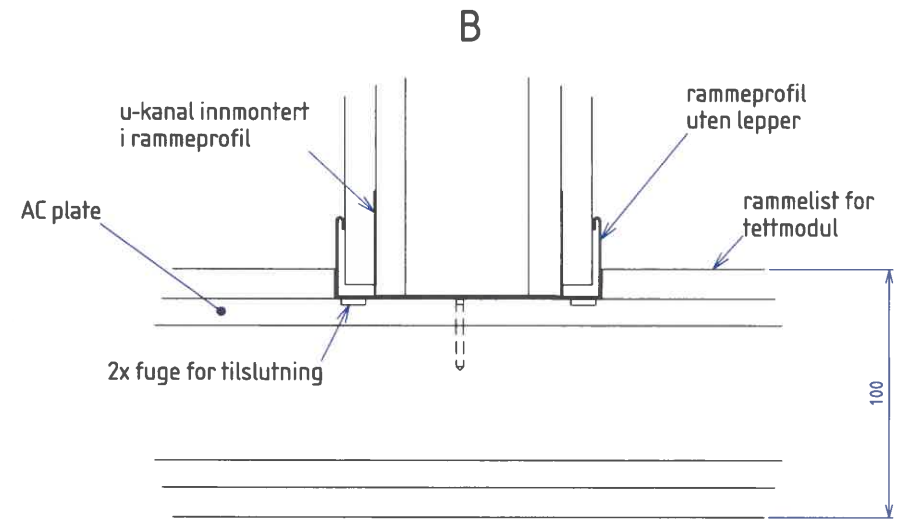
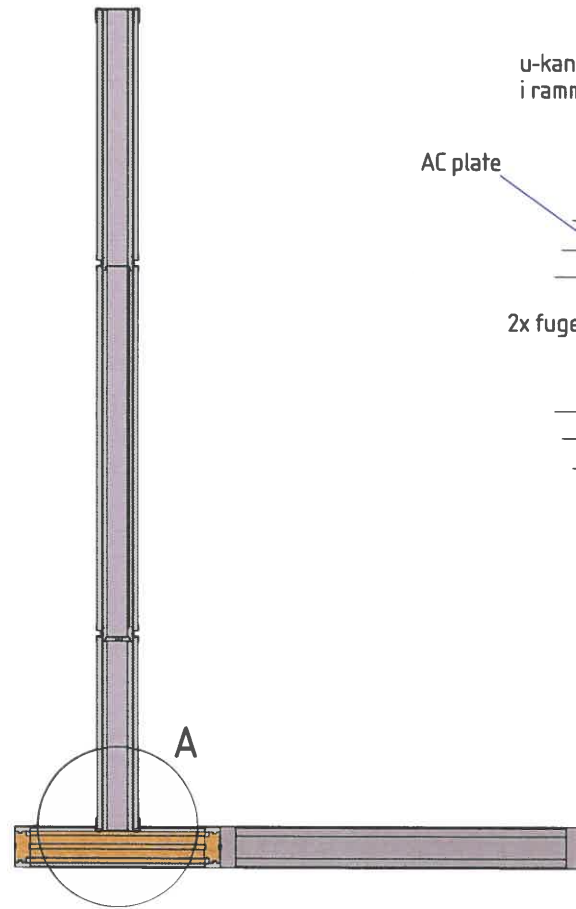
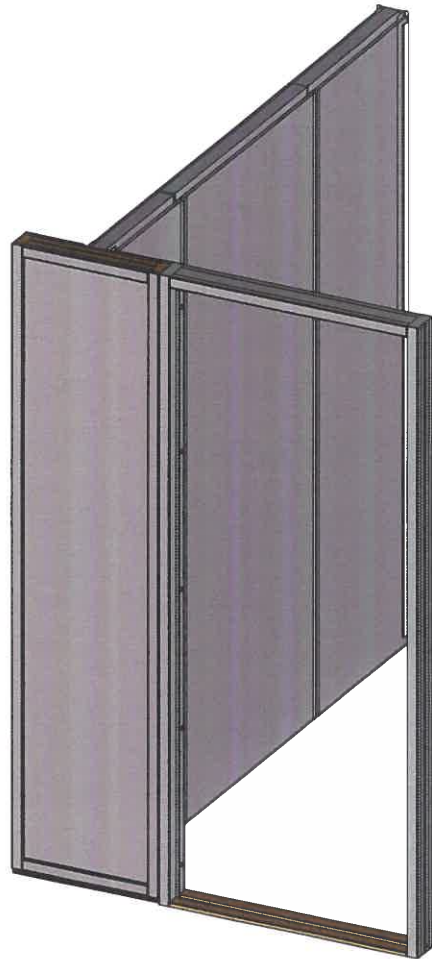

Skala <b>1:10</b>	Tittel <b>MV-100 Brannklassifisert</b>	Tegnet av <b>Rune L</b>	Godkjent av <b>Lars N</b>
		Dato <b>07/04/2014</b>	Revidert dato <b>18/04/2024</b>
		Tegningsnummer <b>6001850</b>	Rev. nr. <b>B</b>
<b>A3</b>	<b>HATTEPROFILVEGG MONTERT MOT EI30 TETTMODUL</b>		Toleranse <b>-</b>