



Montasjeanvisninger:

MV-V-Fas Kontorskillevegg

Tegn.nr

6001777 Plater montert med klips, vegg 1+1

6001780 Plater montert med klips, vegg 1+2

6001781 Plater montert med klips, vegg 2+2

Art.nr.6-2900020

maks H (H/300) = 3000mm (enkel stender 75mm)

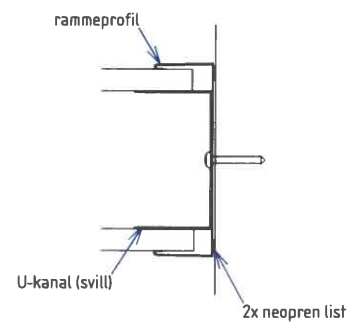
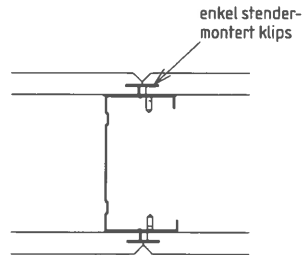
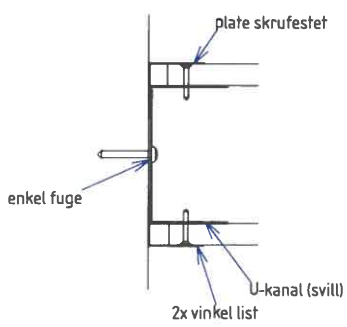
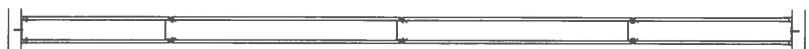
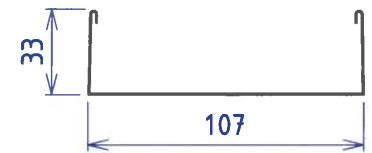
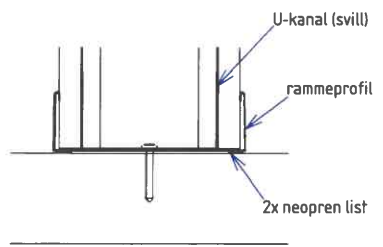
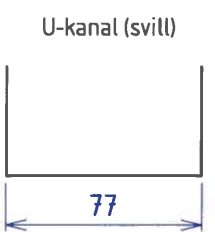
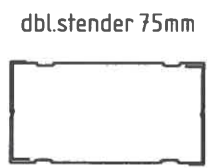
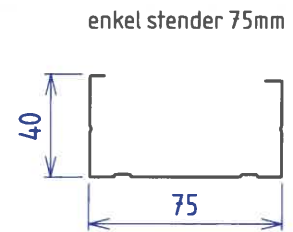
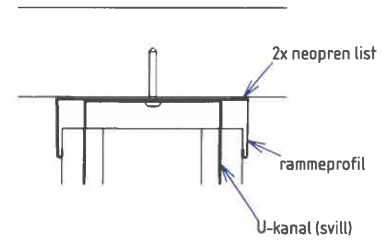
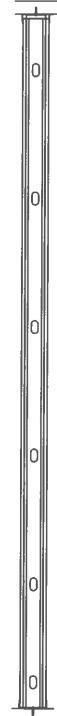
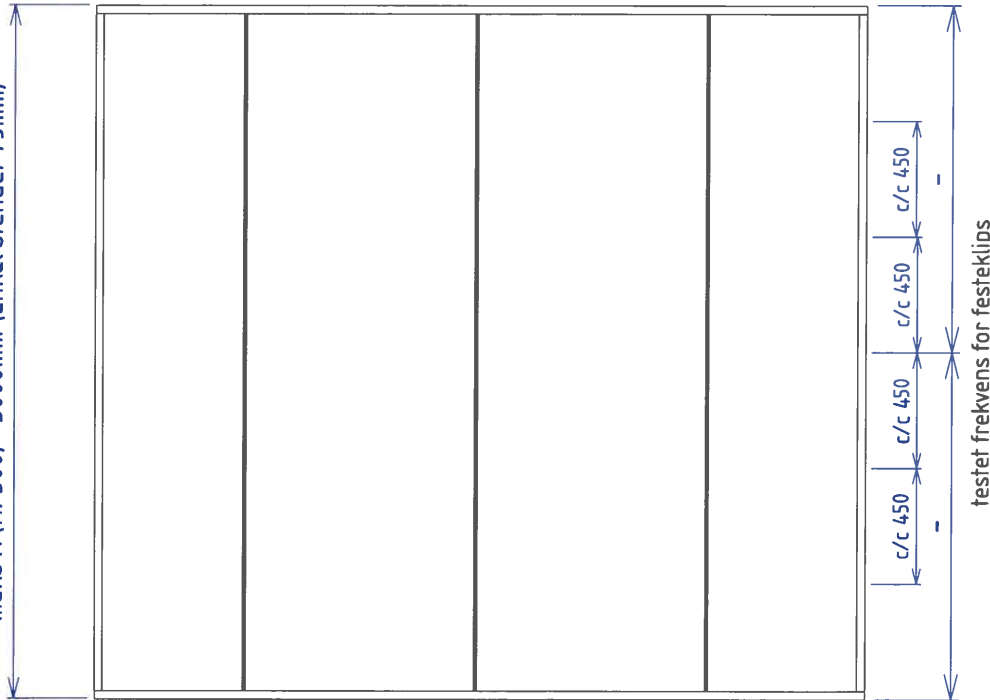

festeklips

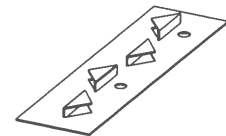

stag-for enkel stender



Skala 1:2	Tittel MV-V.FAS	Tegnet av Rune L	Godkjent av Lars N
		Dato 28/01/2014	Revidert dato 15/02/2024
A3	1+1 VEGG, PLATER MONTERT MED KLIPS	Tegningsnummer 6001777	Rev. nr. B
		Toleranse	



MODULVEGGER

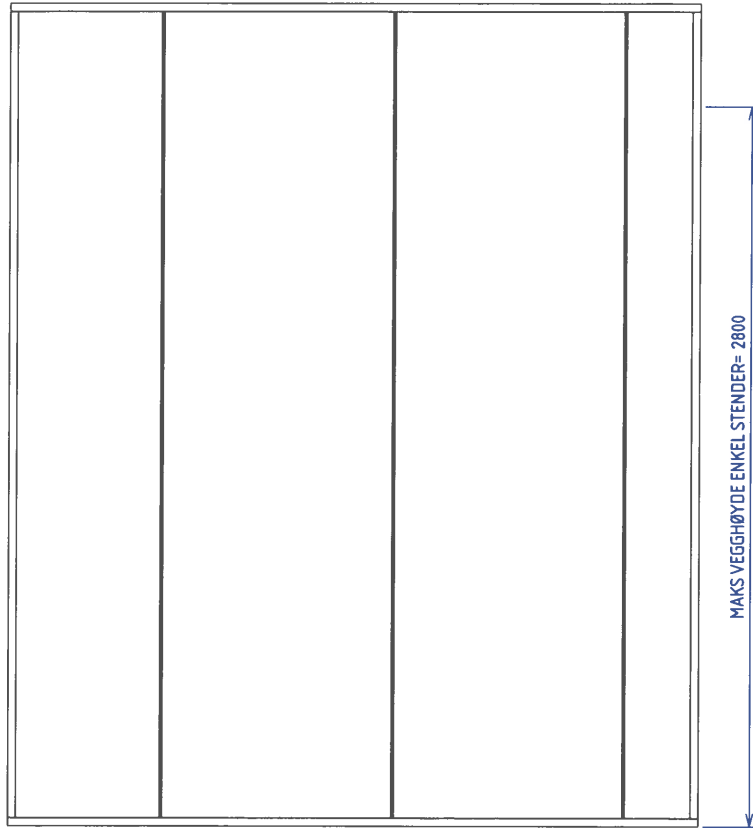

NEOPREN
TETTELISTER

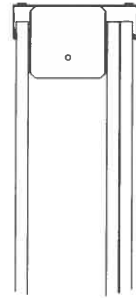

50MM ISOLASJON,
BYGGKVALITET

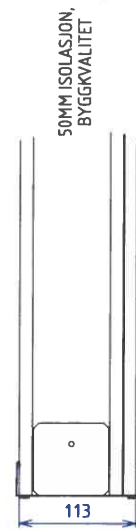

NEOPREN
TETTELISTER

75MM STENDER, DOBLES
VED VEGGHØYDE H > 2800MM
VED KRAV H/300.

KLIPS FOR V-FAS PLATER
MONTERT C/C 300MM

75MM STÅLSTENDER



RAMMEPROFIL
MED LEPPER

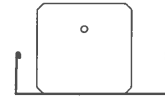

75MM STÅLSTENDER,
DOBDEL (BOKSET)



AVSTIVER STAG,
ENKEL STENDER



U-KANAL (SVILL)



V-FAS FESTEKLIPS



STENDERVERK MONTERT C/C 900MM

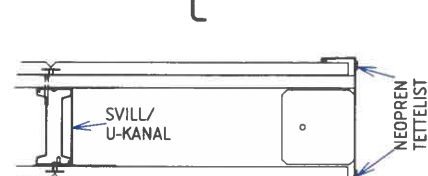
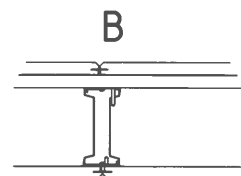
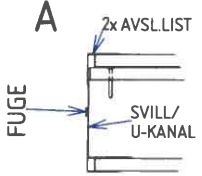
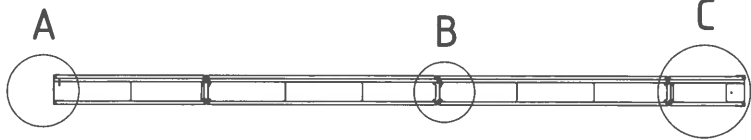

ill. avslutning vegg med
bruk av svill og avslutningslist

ill. doblet stender, festeklips og
liggende platelag skrufestet til stender,
hold for isolasjon med avstandstag.

ill. start vegg med bruk av rammeprofil
og alternativt hold for isolasjon med svill
påmontert stender

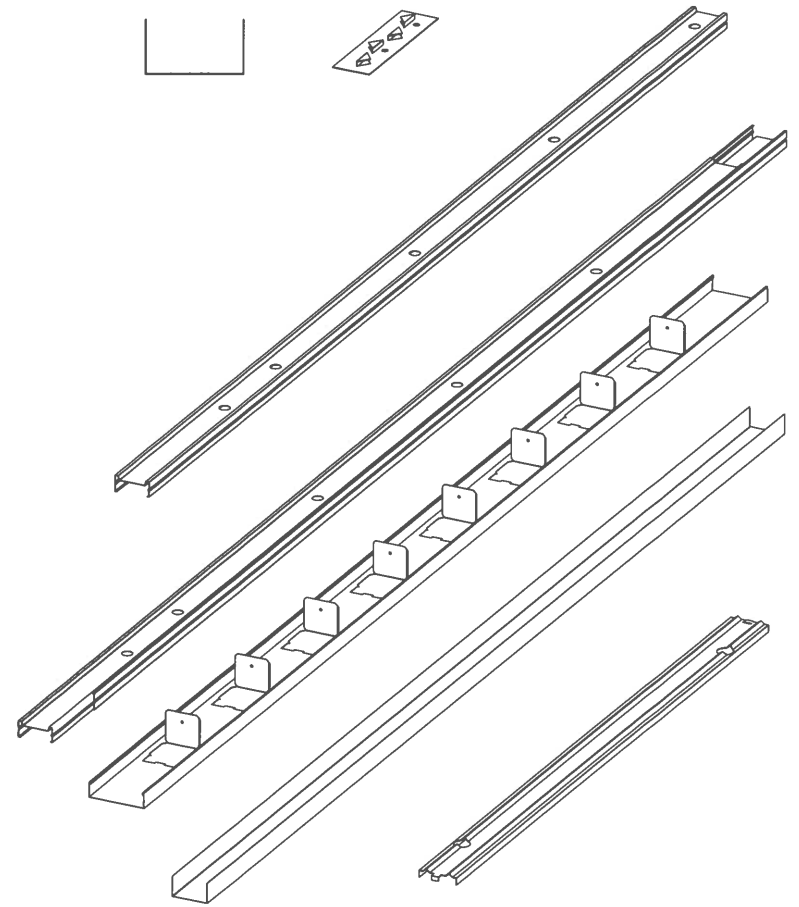
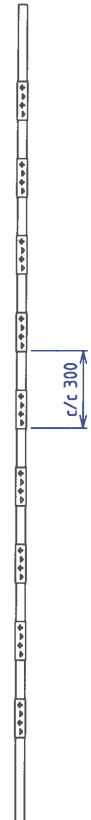

Skala 1:2	Tittel MV-V.FAS	Tegnet av Rune L	Godkjent av Lars N
		Dato 29/01/2014	Revidert dato 00/00/0000
	MODULVEGGER	Tegningsnummer 6001780	Rev. nr. A
		A3 1+2 VEGG, PLATER MONTERT MED KLIPS	

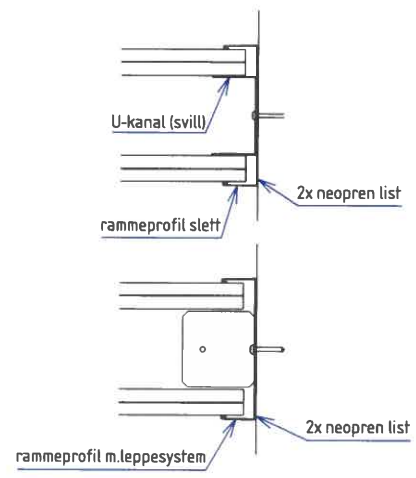
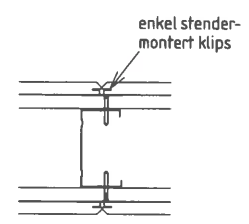
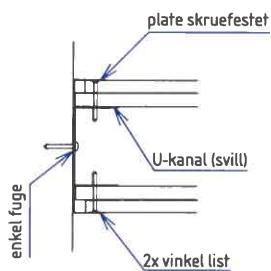
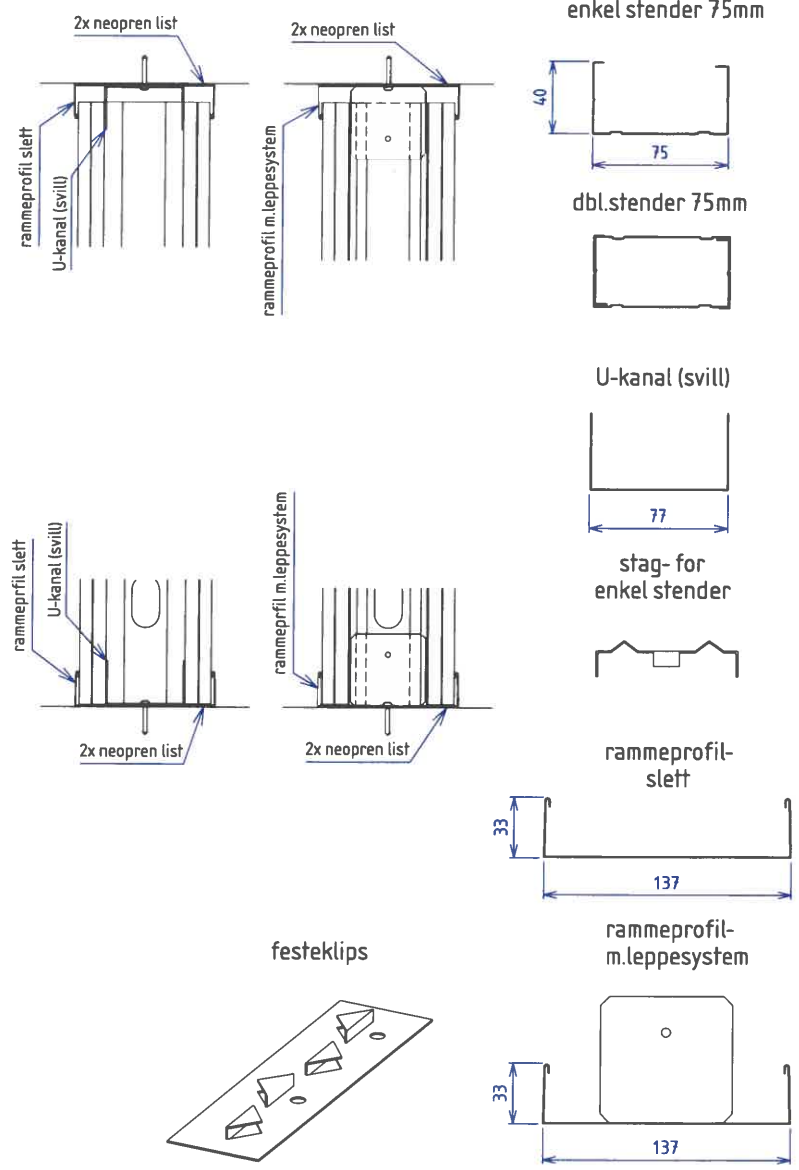
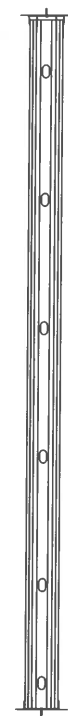
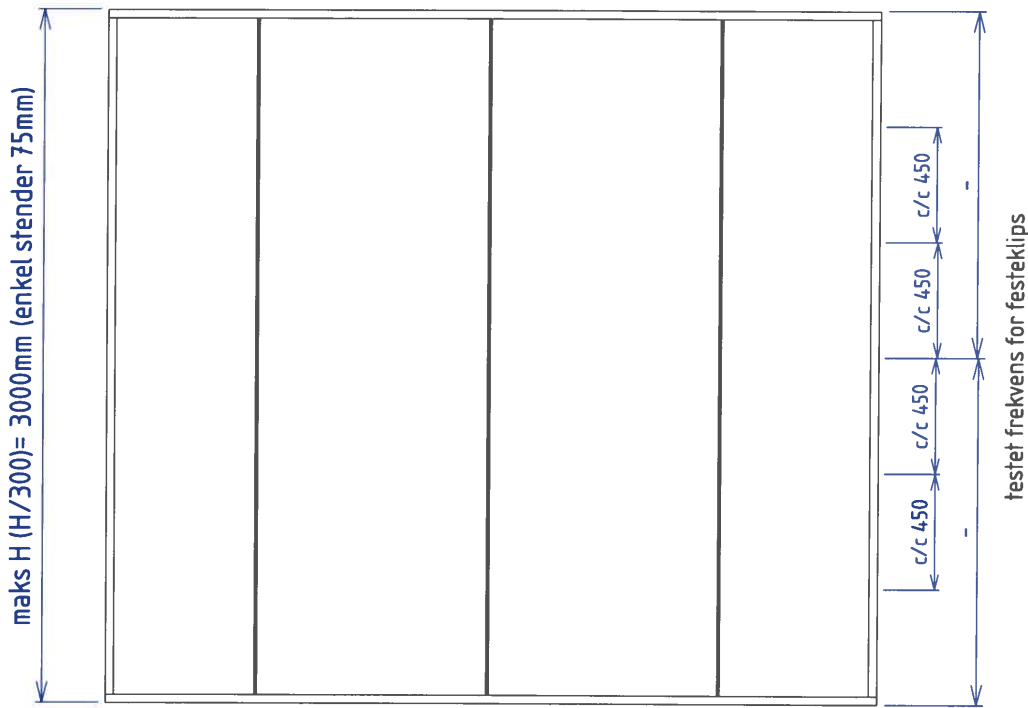

Skala 1:2	Tittel MV-V.FAS	Tegnet av Rune L	Godkjent av Lars N
		Dato 29/01/2014	Revidert dato 22/02/2024
A3	MODULVEGGER	Tegningsnummer 6001781	Rev. nr. B
		Toleranse	
2+2 VEGG, PLATER MONTERT MED KLIPS			